

Section Contents	NADCA No.	Format	Page
Frequently Asked Questions (FAQ)			4A-2
1 Introduction			4A-2
2 Section Objectives			4A-3
3 Standard and Precision Tolerances			4A-3
4 Production Part Technologies			4A-4
5 Die Casting, SSM & Squeeze Cast Part Design			4A-6
6 Linear Dimensions Tolerances	S-4A-1-09	Standard	4A-7
	P-4A-1-09	Precision	4A-8
7 Parting Line Tolerances	S-4A-2-09	Standard	4A-9
	P-4A-2-09	Precision	4A-10
8 Moving Die Component Tolerances	S-4A-3-09	Standard	4A-11
	P-4A-3-09	Precision	4A-12
9 Angularity Tolerances	S/P-4A-4-09	Standard/Precision	4A-13
10 Concentricity Tolerances	S-4A-5-09	Standard	4A-17
11 Parting Line Shift	S-4A-6-09	Standard	4A-19
12 Draft Tolerances	S/P-4A-7-09	Standard/Precision	4A-21
13 Flatness Tolerances	S-4A-8-09	Standard	4A-29
	P-4A-8-09	Precision	4A-30
14 Design Recommendations: Cored Holes As-Cast			4A-31
15 Cored Holes for Cut Threads	S-4A-9-09	Standard	4A-34
	P-4A-9-09	Precision	4A-35
16 Cored Holes for Formed Threads	P-4A-10-09	Precision	4A-36
17 Cored Holes for Pipe Threads	S-4A-11-09	Standard	4A-38
18 Cast Threads	S-4A-12-09	Standard	4A-39
19 Machining Stock Allowance	S/P-4A-13-09	Standard/Precision	4A-40
20 Additional Considerations for Large Castings			4A-42

Engineering & Design: Coordinate Dimensioning

Tolerance in any part is a three-dimensional characteristic. Many different types of tolerance will be discussed throughout sections 4A and 4B. Most feature tolerances will have Linear Tolerance in combination with Projected Area Tolerance to give an overall feature "volumetric" tolerance like Parting Line, Moving Die Component (MDC) and Angularity Tolerances.

Projected Area is the area of a specific feature projected into a plane. For parting line and parting line shift the Projected Area is the open area of the die cavity in the parting line plane. For example, if a die half was laid down and filled with liquid, the surface of the liquid is the Projected Area of the parting line. For the MDC, the Projected Area is determined using the same method as for a parting line. See the applicable figures in the appropriate sections for Projected Area.

Linear Tolerance is calculated from a line perpendicular to any feature. The Parting Line line is the total depth of molten material on both die halves, which is perpendicular to the parting line plane. The MDC line is the length of the core slide which is perpendicular to the head of the core slide. Length of a core slide is determined from the point where the core first engages the die to its full insertion point.

Projected Area Tolerance plus Linear Tolerance equals feature tolerance (tolerance of the volume of the part).

See Volumetric Tolerance diagram on the facing page.

Frequently Asked Questions (FAQ)

- 1) What is the difference between Standard and Precision Tolerances?
See pages 4A-3 and 4A-4, 3.0 Standard and Precision Tolerances.
- 2) What is a Parting Line Shift?
See pages 4A-19 and 4A-20, Parting Line Shift.
- 3) If my casting requires machining, how should the casting be dimensioned?
See page 4A-40 and 4A-41, Machining Stock Allowances.
- 4) How large should a cast-in hole be if threads need to be tapped or formed in the casting?
See page 4A-34 and 4A-35, Cored Holes for Cut Threads. Also see pages 4A-36 and 4A-37, Cored Holes for Formed Threads.
- 5) What type of draft should be used on exterior and interior walls?
See pages 4A-21 through 4A-24, Draft Requirements.
- 6) What type of flatness tolerance can be expected on a cast surface?
See pages 4A-29 and 4A-30, Flatness Requirements.

1 Introduction

Die casting requires a specific degree of precision for the end product to meet the requirements of form, fit and function. However there is a cost associated with increased precision.

Some of the costs associated with a higher degree of tolerance include:

- *Decreased die life due to wear that puts die dimensions outside of specified high precision tolerance*
- *More frequent die repair or replacement to maintain a high precision tolerance*
- *More frequent shutdown (shorter production runs) to repair or replace dies*
- *More frequent part or die inspections to ensure high precision tolerance is maintained*
- *Potential for higher scrap rate for not maintaining specified high precision tolerance*

A good casting design will take into account not only the precision required to meet the requirements of form, fit and function, but will also take into account maximizing tolerance to achieve a longer die life and longer production runs with less inspections. This will result in less potential for scrap and more acceptable parts because the tolerance range for acceptable parts has increased.

In section 4A tolerance will be specified in two values. Standard Tolerance is the lesser degree of precision that will meet most applications of form, fit and function. It is specified in thousandths of an inch (0.001) or hundredths of a millimeter (0.01). Degree of variation from design specified values is larger than that of Precision Tolerance as shown in graphical representation at the end of section 4A.

Precision Tolerance is a higher degree of precision used for special applications where form, fit and function are adversely affected by minor variations from design specifications. Precision Tolerance is also specified in thousandths of an inch or hundredths of a millimeter. However, its variation from design specified values is less than that of Standard Tolerances.

Examples of tolerance application may be an engine casting that uses Standard Tolerance. Form, fit and function are not critical since moving parts will be encased in sleeves that are cast into place. Variations in size will be filled with cast metal.

Standard Tolerance meets the criteria for this application as part of the design. However a gas line fitting may require a higher degree of precision so that mating parts fit together to prevent leaks. Precision gas fittings may cost more to produce because of the higher degree of precision that must be maintained.

Degree of precision depends on the applications of form, fit and function which resides with the design engineer's expectation of part performance.

Cast components can be specified and produced to an excellent surface finish, close dimensional tolerances and to minimum draft, among other characteristics.

All of the capabilities of the casting process, specified to maximum degree, will rarely, if ever, be required in one cast part. For the most economical production, the design engineer or specifier should attempt to avoid such requirements in a single component.

It is important for the product designer and engineer to understand precisely how today's die casting process can be specified in accordance with the capabilities of the die casting industry.

Engineering & Design: Coordinate Dimensioning

2 Section Objectives

The Engineering and Design Sections of this document are prepared to aid product specifiers in achieving the most cost-effective results through net-shape and near-net-shape casting production. They present both English and Metric values on the same page.

Section 4A presents standard/precision tolerances and other specifications for die cast parts ranging from a fraction of an inch (several millimeters) to several feet (meter) in size. Material weight ranges from a fraction of an ounce (several milligrams) to thirty pounds (kilograms) or more.

Section 4B presents standard/precision tolerances and other specifications for miniature die cast parts ranging from hundredths of an inch (tenths of a millimeter) to several inches (several centimeters) in size. Material weights ranging from a fraction of an ounce (several milligrams) to about 16 ounces (454 grams).

Section 5 presents Geometric Dimensioning, which provides guidelines for applying tolerances to cast part specifications.

These sections provide information for developing the most economically produced design that meets the specifications of form, fit and function.

3 Standard and Precision Tolerances

As noted in the contents for this section, seven important sets of tolerancing guidelines are presented here as both “Standard” and “Precision” Tolerances:

- *Linear dimensions*
- *Dimensions across parting Lines*
- *Dimensions formed by moving die components (MDC)*
- *Angularity*
- *Draft*
- *Flatness*
- *Cored holes for threads*

The following features are only specified in Standard Tolerance. Unlike the features above, parts that exceed the following tolerances will not meet the requirements of form, fit and function. These features are specified at the maximum tolerance to meet their requirements. These features include:

- *Concentricity*
- *Parting Line Shift*

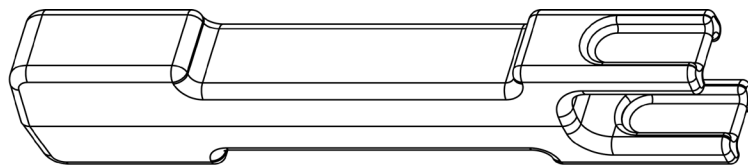

$$\text{Volume} = 7.39 \text{ in}^3$$

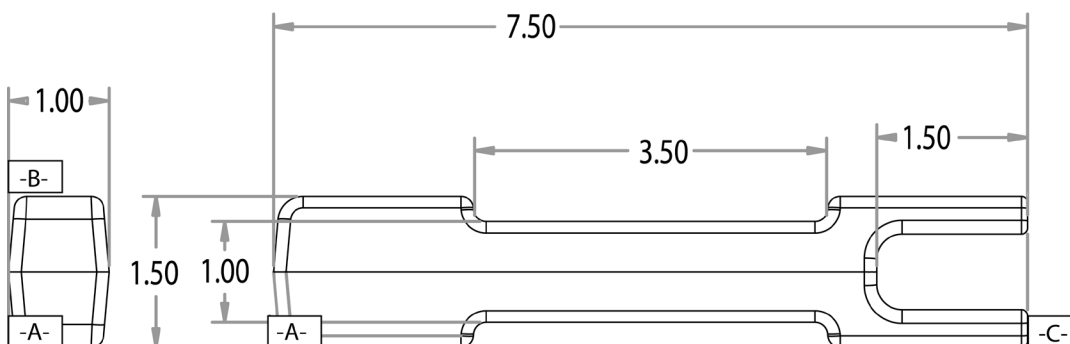

Volumetric Tolerance for Across Parting Line Features

(See diagram on this page.)

Parting Line Projected Area is defined by the horizontal center line shown in the figure below. Its dimensions are 1.00 inch wide by (7.50 - 1.50) inches long. The Projected area is (1.00 x 6.00) or 6.00 in. sq. This is the surface area used for features across the parting line. Tolerance is expressed in inches.

Linear Dimension (depth of cavity on both die halves) is 1.50 inches. This is the linear dimension used to determine Linear Tolerance.

Feature Tolerance is Projected Area Tolerance plus Linear Area Tolerance.

Graphical Representation

Throughout section 4A there is graphical representation of specific feature tolerances.

Precision tolerances are generally closer to design specifications than standard tolerances. The x-axis along y-axis at zero indicates actual design specification. Graph lines indicate the maximum allowable deviation from design specification.

4A

Engineering & Design: Coordinate Dimensioning

Standard Tolerances

Standard Tolerances cover expected values consistent with high casting cycle speeds, uninterrupted production, reasonable die life and die maintenance costs, as well as normal inspection, packing and shipping costs.

Such tolerances can normally be achieved by the widely available production capabilities of casters practicing standard methods and procedures. Conformity to these standards by designers assures the most predictable service and lowest cost.

Precision Tolerances

Critical requirements for dimensional accuracy, draft, etc., beyond the Standard Tolerances presented, can be specified when required.

Precision Tolerances are presented on the page facing the Standard Tolerances for the same characteristic. The values shown for Precision Tolerances represent greater casting accuracy. See graphical comparison of Standard and Precision Tolerances throughout section 4A. Part precision tolerances involve extra precision in die construction and/or special process controls during production. The use of new technologies and equipment aid in maintaining Precision Tolerance.

While early consultation with the caster can result in selected special precision requirements being incorporated with little additional cost, such tolerances should be specified only where necessary.

It should be noted that the tolerances shown must, of necessity, be guidelines only—highly dependent on the particular shape, specific features and wall thickness transitions of a given part design. These factors, under the control of the product designer, greatly influence the ability of the casting process to achieve predetermined specifications in the final cast part.

Where a number of critical requirements are combined in a single casting, early caster evaluation of a proposed design is essential. Design modifications for more cost-efficient casting can nearly always be made. Without such feedback, additional costs can usually be expected and the design, as originally planned, may be not be producible by die casting.

When specific designs are examined, tolerances even closer than the Precision Tolerances shown can often be held by repeated production sampling and recutting of the die casting die, together with production capability studies. While such steps will result in additional tooling and production costs, the significant savings that can result by eliminating substantial secondary machining and/or finishing operations can prove highly cost effective.

4 Production Part Technologies

This section presents advantages and limitations of various production technologies for a simple part such as the one shown in Fig. 4A-1. The section that follows presents the die cast alternative and its advantages and limitations.

Metal Stamping Alternative

This part design, as pictured in the side profile Fig. 4A-1 and if designed to a minimum thickness without additional complexities, could be considered for volume production by the metal stamping process. Metal stamping lends itself to high-speed production with infrequent die replacement or repair. However, the stamping process can only produce features that are apparent on both sides of a thin part. Indentations on one side of the part appear as ridges on the other side of the part. Critical

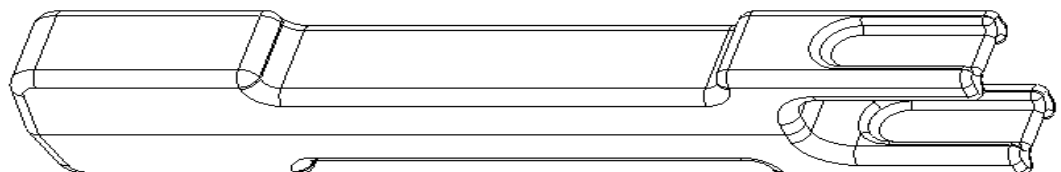

Fig. 4A-1 Proposed component.

Engineering & Design: Coordinate Dimensioning

bends in the metal surface of stamped products become areas of weakness where metal is yielded to make the bend. Complex features within the layer of metal are impossible without additional stamped parts and assembly. Thicker parts require higher stamping pressure which compounds metal fatigue at critical bends. This is similar to a large tree snapping in the wind where a sapling will bend. Multiple stamped layers and assembly would exceed the cost of the die cast alternative.

Extrusion Alternative

If the part design required stock depth beyond stamping capabilities, the extrusion process might be a production alternative for creating such a profile—unless complex additional interior features were desirable, such as those shown in Fig. 4A-1.

When total costs of a product assembly can be significantly reduced by a more robust part design, as that suggested by Fig. 4A-1, the production process which allows such design freedom is the better choice. The extrusion process produces a uniform internal structure in one axis such as a bar or a tube. End features or variations within the axis are impossible. A part, such as the one shown in Fig. 4A-1, has design feature variations on all axes therefore extrusion of this part is not possible without multiple operations which would exceed the cost of the die cast alternative.

Machining Alternative

Automated machining could produce product features as shown in Fig. 4A-1. Complex features would require additional operations for each piece. This would be very time consuming and would place tremendous wear on production equipment especially during large volume production. As volumes increased, machining would become a very high-cost production option.

Foundry Casting Alternative

Foundry casting plus secondary machining might be an alternative for this part. Foundry casting involves pouring molten metal into a mold. Without the pressure of die, SSM or squeeze casting to force metal into critical paths, around tight turns, and into small features of the mold, Foundry casting can not achieve the detail and precision of die, SSM or squeeze casting. The Foundry casting process is relatively slow in that gravity fills and mold positions take time to achieve.

Extensive secondary machining is required for Foundry castings when close tolerances are required. This is not only costly but time consuming. Foundry casting is usually reserved for large iron castings with very little intricate detail. It is not considered as a high volume process. Net-shape die casting can become the more cost-effective solution, often at low production volumes.

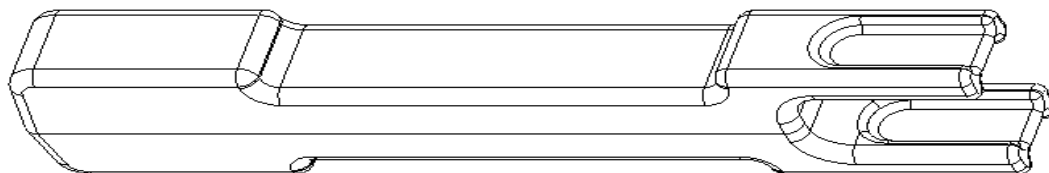
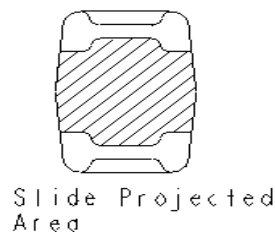

FIG. 4A-1A PROPOSED COMPONENT WITH ADDED FEATURES AND DESIGN MODIFIED FOR COST-EFFECTIVE DIE CASTING PRODUCTION, SHOWING ORIENTATION IN THE DIE CASTING DIE AND CORE SLIDE (MOVING DIE COMPONENT) TO CAST THE ADDITIONAL FEATURES.

Engineering & Design: Coordinate Dimensioning

Investment Casting Alternative

At low volumes the investment casting process could be considered to achieve precision tolerances. At higher volumes die casting would be the clear choice.

Powdered Metal Alternative

The powdered metal process offers dimensional accuracy for many parts. It cannot achieve the more complex configurations, detailed features or thinner walls which die casting can easily produce to net-or near-net shape.

Plastic Molded Alternative

Plastic injection molding could achieve the designed configuration shown in Fig. 4A-1, but if requirements of rigidity, creep resistance, and strength—particularly at elevated temperatures—were important, plastics would be questionable. The longevity of plastic components is normally substantially less than that of metal components. Plastics products are subject to failure modes such as sunlight, radiation, heat and various chemicals. The designer needs to ensure that the application and duration of the end product will meet the customer's needs and expectations. Additionally, the preference for use of a recycled raw material as well as the potential for eventual recycling of the product at the end of its useful life would also support a decision for die casting.

5 Die Casting, SSM and Squeeze Cast Part Design

Fig. 4A-1A, illustrates a good design practice for die, SSM and squeeze casting production.

Sharp corners have been eliminated and the design has been provided with the proper draft and radii to maximize the potential die life and to aid in filling the die cavity completely under high production cycle speeds.

Typical wall thicknesses for a cast design range from 0.040 in. (1.016 mm) to 0.200 in. (5.08 mm), depending on alloy, part configuration, part size and application.

Smaller castings with wall sections as thin as 0.020 in. (0.50 mm) can be cast, with die caster consultation. For extremely small zinc parts, miniature die casting technology can be used to cast still thinner walls. See section 4B for information on miniature die casting.

Fig. 4A-1 will be used elsewhere in this section to present dimensional tolerances, specifically as they relate to part dimensions on the same side of the die half, across the parting line, and those formed by moving die components.

Fig. 4A-1 will also be used in the Geometric Dimensioning Section to show how datum structure can influence tooling and tolerances.

6 Linear Dimensions: Standard Tolerances

The Standard Tolerance on any of the features labeled in the adjacent drawing, dimension “E₁” will be the value shown in table S-4A-1 for dimensions between features formed in the same die part. Tolerance must be increased for dimensions of features formed by the parting line or by moving die parts to allow for movement such as parting line shift or the moving components in the die itself. See tables S-4A-2 and S-4A-3 for calculating precision of moving die components or parting line shift. Linear tolerance is only for fixed components to allow for growth, shrinkage or minor imperfections in the part.

Tolerance precision is the amount of variation from the part’s nominal or design feature.

For example, a 5 inch design specification with ±0.010 tolerance does not require the amount of precision as the same part with a tolerance of ±0.005. The smaller the tolerance number, the more precise the part must be (the higher the precision). Normally, the higher the precision the more it costs to manufacture the part because die wear will affect more precise parts sooner. Production runs will be shorter to allow for increased die maintenance. Therefore the objective is to have as low precision as possible without affecting form, fit and function of the part.

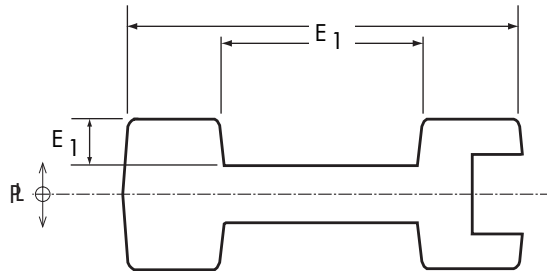

Example: An aluminum casting with a 5.00 in. (127 mm) specification in any dimension shown on the drawing as “E₁”, can have a Standard Tolerance of ±0.010 inch (±0.25 mm) for the first inch (25.4 mm) plus ±0.001 for each additional inch (plus ±0.025 mm for each additional 25.4 mm). In this example that is ±0.010 for the first inch plus ±0.001 multiplied by the 4 additional inches to yield a total tolerance of ±0.014. In metric terms, ±0.25 for the first 25.4 mm increments plus ±0.025 multiplied by the 4 additional 25.4 mm to yield a total tolerance of ±0.35 mm for the 127 mm design feature specified as “E₁” on the drawing. Linear dimension tolerance only applies to linear dimensions formed in the same die half with no moving components.

Table S-4A-1 Tolerances for Linear Dimensions (Standard)
In inches, two-place decimals (.xx); In millimeters, single-place decimals (.x)

Length of Dimension "E ₁ "	Casting Alloys			
	Zinc	Aluminum	Magnesium	Copper
Basic Tolerance up to 1" (25.4mm)	±0.010 (±0.25 mm)	±0.010 (±0.25 mm)	±0.010 (±0.25 mm)	±0.014 (±0.36 mm)
Additional Tolerance for each additional inch over 1" (25.4mm)	±0.001 (±0.025 mm)	±0.001 (±0.025 mm)	±0.001 (±0.025 mm)	±0.003 (±0.076 mm)

The values shown represent Standard Tolerances, or normal casting production practice at the most economical level. For greater casting accuracy see Precision Tolerances for this characteristic on the facing page. Be sure to also address the procedures referred to in Section 7, “Quality Assurance,” sub-section 3, 4 and 5.

Significant numbers indicate the degree of accuracy in calculating precision. The more significant numbers in a specified tolerance, the greater the accuracy. Significant number is the first non-zero number to the right of the decimal and all numbers to the right of that number. For example, 0.014. The degree of accuracy is specified by the three significant numbers 140. This is not to be confused with tolerance precision. A tolerance limit of 0.007 has a higher degree of precision because it is closer to zero tolerance. Zero tolerance indicates that the part meets design specifications exactly.

4A

Linear Standard and Linear Precision tolerances are expressed in thousandths of an inch (.001) or hundredths of a millimeter (.01).

Notes:

Casting configuration and shrink factor may limit some dimension control for achieving a specified precision.

Linear tolerances apply to radii and diameters as well as wall thicknesses.

The Precision Tolerance values shown represent greater casting accuracy involving extra precision in die construction and/or special control in production. They should be specified only when and where necessary, since additional costs may be involved. Be sure to also address the procedures referred to in Section 7, "Quality Assurance," sub-section 3, 4 and 5.

Linear tolerances apply to radii and diameters as well as wall thicknesses.

Methods for Improving Precision:

1. By repeated sampling and recutting of the die cast tool, along with capability studies, even closer dimensions can be held. However, additional sampling and other costs may be incurred.
2. For zinc die castings, tighter tolerances can be held, depending on part configuration and the use of artificial aging. Artificial aging (also known as heat treating) may be essential for maintaining critical dimensions in zinc, particularly if the part is to be machined, due to the creep (growth) characteristics of zinc. The die caster should be consulted during the part design stage.
3. In the case of extremely small zinc parts, weighing fractions of an ounce, special die casting machines can achieve significantly tighter tolerances, with zero draft and flash-free operation. See Section 4B, Miniature Die Casting.

Linear Dimensions: Precision Tolerances

Precision Tolerance on any of the features labeled in the adjacent drawing, dimension "E₁" will be the value shown in table P-4A-1 for dimensions between features formed in the same die part. Tolerance must be increased for dimensions of features formed by the parting line or by moving die parts to allow for movement such as parting line shift or the moving components in the die itself. See tables P-4A-2 and P-4A-3 for calculating precision of moving die components or parting line shift. Linear tolerance is only for fixed components to allow for growth, shrinkage or minor imperfections in the part.

Example: An aluminum die casting with a 5.00 in. (127 mm) specification in any dimension shown on the drawing as "E₁", can have a Precision Tolerance of ±0.002 inches (±0.05 mm) for the first inch (25.4 mm) plus ±0.001 for each additional inch (plus ±0.025 mm for each additional 25.4 mm). In this example that is ±0.002 for the first inch plus ±0.001 multiplied by the 4 additional inches to yield a total tolerance of ±0.006.

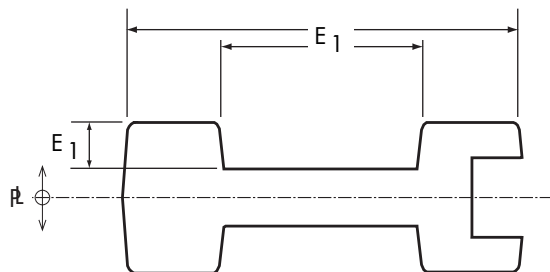

In metric terms, ±0.05 for the first 25.4 mm plus ±0.025 multiplied by the 4 additional 25.4 mm increments to yield a total tolerance of ±0.15 mm for the 127 mm design feature specified as "E₁" on the drawing. Linear dimension tolerance only applies to linear dimensions formed in the same die half with no moving components.

Table P-4A-1 Tolerances for Linear Dimensions (Precision)
In inches, three-place decimals (.xxx); In millimeters, two-place decimals (.xx)

Length of Dimension "E ₁ "	Casting Alloys			
	Zinc	Aluminum	Magnesium	Copper
Basic Tolerance up to 1" (25.4mm)	±0.002 ^(A) (±0.05 mm)	±0.002 (±0.05 mm)	±0.002 (±0.05 mm)	±0.007 (±0.18 mm)
Additional Tolerance for each additional inch over 1" (25.4mm)	±0.001 (±0.025 mm)	±0.001 (±0.025 mm)	±0.001 (±0.025 mm)	±0.002 (±0.05 mm)

Linear Tolerance

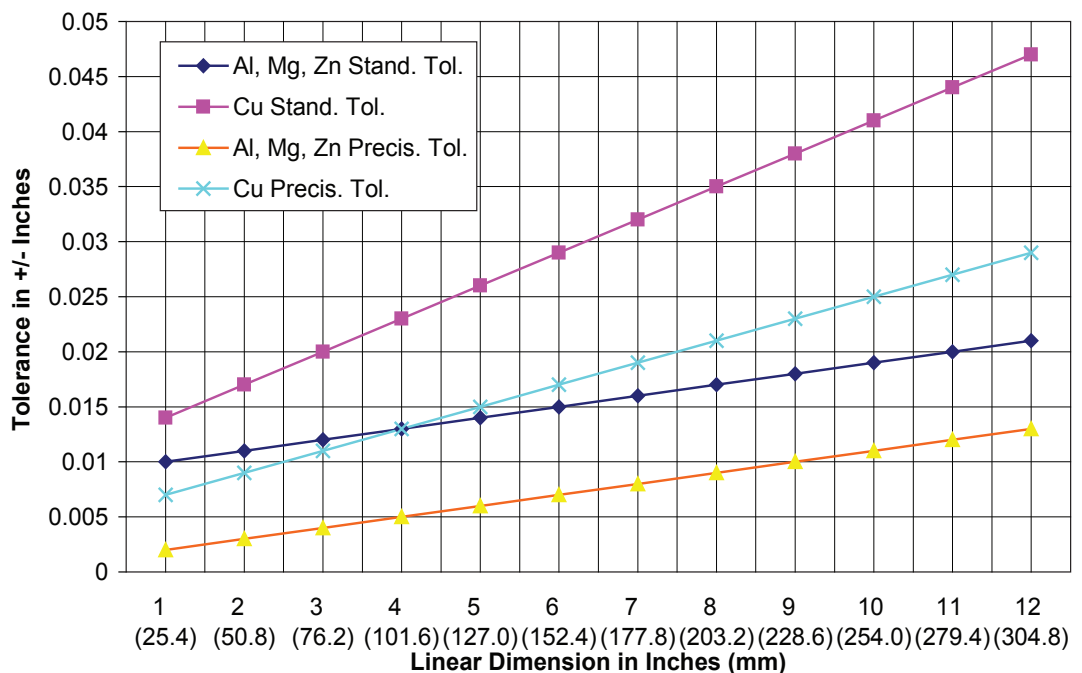

7 Parting Line: Standard Tolerances

Parting Line Tolerance is the maximum amount of die separation allowed for the end product to meet specified requirements of form, fit and function. This is not to be confused with Parting Line Shift Tolerance which is the maximum amount die halves shift from side to side in relation to one another.

An example of Parting Line Tolerance is the amount a door is allowed to be opened and still call it closed. An example of Parting Line Shift Tolerance is how well the door fits in the frame. Worn hinges may cause the door to drag on the floor so that it can not be closed and therefore not perform its intended function. Parting Line Shift Tolerance will be discussed later in this section.

Parting Line Tolerance is a function of the surface area of the die from which material can flow from one die half to the other. This is also known as Projected Area.

Projected Area is always a plus tolerance since a completely closed die has 0 separation. Excess material and pressure will force the die to open along the parting line plane creating an oversize condition. The excess material will cause the part to be thicker than the ideal specification and that is why Projected Area only has plus tolerance. It is important to understand that Table S-4A-2 (Projected Area Tolerance) does not provide Parting Line Tolerance by itself. Part thickness or depth must be factored in to give a true idea of Parting Line Tolerance. Parting Line Tolerance is a function of part thickness perpendicular to the Projected Area plus the Projected Area Tolerance.

Part thickness includes both die halves to give a volumetric representation of Parting Line Tolerance. Information from the Projected Area Tolerance table S-4A-2 in combination with the formerly discussed Linear Tolerance table S-4A-1 give a true representation of Parting Line Tolerance. Note that the tolerances in the table apply to a single casting regardless of the number of cavities.

Example: An aluminum die casting has 75 in² (483.9 cm²) of Projected Area on the parting die plane. From table S-4A-2, Projected Area Tolerance is +0.012. This is combined with the total part thickness tolerance from table S-4A-1 to obtain the Parting Line Tolerance.

The total part thickness including both die halves is 5.00 in. (127 mm) which is measured perpendicular to the parting die plane (dimension "E₂ E₁"). From table S-4A-1, the Linear Tolerance is ±0.010 for the first inch and ±0.001 for each of the four additional inches. The Linear Tolerance of ±0.014 inches is combined with the Projected Area Tolerance of +0.012 to yield a Standard Parting Line Tolerance of +0.026/-0.014 in. or in metric terms ±0.35 mm from Linear Tolerance table S-4A-1 plus +0.30 mm from Projected Area Tolerance table S-4A-2 = +0.65/-0.35 mm.

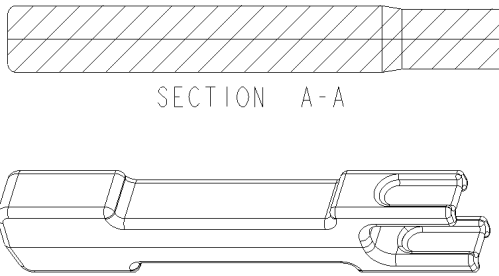

The values shown represent Standard Tolerances, or normal die casting production practice at the most economical level. For greater casting accuracy see Precision Tolerances for this characteristic on the facing page. Be sure to also address the procedures referred to in Section 7, "Quality Assurance," sub-section 3, 4 and 5.

Die Shift:

Parting line die shift, unlike parting line separation and moving die component tolerances, is a left/right relationship with possible ± consequences. It can shift in four directions, based on a combination of part features, die construction and operation factors. It can occur at any time and its tolerance consequences should be discussed with the die caster at the design stage to minimize any impact on the final die casting.

Notes:

All values for part dimensions which run across the die parting line are stated as a "plus" tolerance only. The die casting die at a die closed position creates the bottom of the tolerance range, i.e., 0.000 (zero). Due to the nature of the die casting process, dies can separate imperceptibly at the parting line and create only a larger, or "plus" side, tolerance.

Table S-4A-2 Parting Line Tolerances (Standard) – Added to Linear Tolerances

Projected Area of Die Casting inches ² (cm ²)	Casting Alloys (Tolerances shown are "plus" values only)			
	Zinc	Aluminum	Magnesium	Copper
up to 10 in ² (64.5 cm ²)	+0.0045 (+0.114 mm)	+0.0055 (+0.14 mm)	+0.0055 (+0.14 mm)	+0.008 (+0.20 mm)
11 in ² to 20 in ² (71.0 cm ² to 129.0 cm ²)	+0.005 (+0.13 mm)	+0.0065 (+0.165 mm)	+0.0065 (+0.165 mm)	+0.009 (+0.23 mm)
21 in ² to 50 in ² (135.5 cm ² to 322.6 cm ²)	+0.006 (+0.15 mm)	+0.0075 (+0.19 mm)	+0.0075 (+0.19 mm)	+0.010 (+0.25 mm)
51 in ² to 100 in ² (329.0 cm ² to 645.2 cm ²)	+0.009 (+0.23 mm)	+0.012 (+0.30 mm)	+0.012 (+0.30 mm)	—
101 in ² to 200 in ² (651.6 cm ² to 1290.3 cm ²)	+0.012 (+0.30 mm)	+0.018 (+0.46 mm)	+0.018 (+0.46 mm)	—
201 in ² to 300 in ² (1296.8 cm ² to 1935.5 cm ²)	+0.018 (+0.46 mm)	+0.024 (+0.61 mm)	+0.024 (+0.61 mm)	—

For projected area of die casting over 300 in² (1935.5 cm²), consult with your die caster.

The Precision Tolerance values shown represent greater casting accuracy involving extra precision in die construction and/or special control in production. They should be specified only when and where necessary, since additional costs may be involved. Be sure to also address the procedures referred to in Section 7, "Quality Assurance," sub-section 3, 4 and 5.

Parting Line: Precision Tolerances

Precision Tolerances on dimensions such as "E₂ E₁", which are perpendicular to (across) the die parting line, will be the linear dimension tolerance from table P-4A-1 plus the value shown in table P-4A-2. The value chosen from the table below depends on the "projected area" of the part, in inches squared or millimeters squared, in the plane of the die parting. Note that the tolerances shown below are "plus side only" and based on a single cavity die casting die.

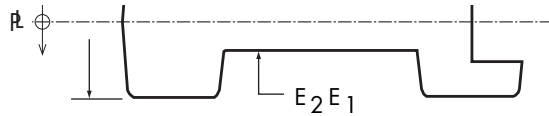

Example: An aluminum die casting has 75 in² (483.9 cm²) of Projected Area on the parting die plane. From table P-4A-2, Projected Area Tolerance is +0.008. This is combined with the total part thickness from table P-4A-1 to obtain the Parting Line Tolerance.

Total part thickness including both die halves is 5.000 in. (127 mm) which is measured perpendicular to the parting die plane (dimension "E₂ E₁"). From table P-4A-1, the Linear Tolerance is ±0.002 for the first inch and ±0.001 for each of the four additional inches. The Linear Tolerance of ±0.006 is combined with the Projected Area Tolerance of +0.008 to yield a Precision Parting Line Tolerance of +0.014/-0.006 in. or in metric terms (±0.15 mm plus +0.20 mm) = +0.35/-0.15 mm on dimensions that are formed across the parting line.

Methods for Improving Precision:

- By repeated sampling and recutting of the die cast tool, along with capability studies, even closer dimensions can be held. However, additional sampling and other costs may be incurred.
- For zinc die castings, tighter tolerances can be held, depending on part configuration and the use of artificial aging. Artificial aging (also known as heat treating) may be essential for maintaining critical dimensions in zinc, particularly if the part is to be machined, due to the creep (growth) characteristics of zinc. The die caster should be consulted during the part design stage.
- In the case of extremely small zinc parts, weighing fractions of an ounce, special die casting machines can achieve significantly tighter tolerances, with zero draft and flash-free operation. See Section 4B, Miniature Die Casting.

Table P-4A-2 Parting Line Tolerances (Precision) – Added to Linear Tolerances

Projected Area of Die Casting inches ² (cm ²)	Die Casting Alloys (Tolerances shown are "plus" values only)			
	Zinc	Aluminum	Magnesium	Copper
up to 10 in ² (64.5 cm ²)	+0.003 (A) (+0.076 mm)	+0.0035 (+0.089 mm)	+0.0035 (+0.089 mm)	+0.008 (+0.20 mm)
11 in ² to 20 in ² (71.0 cm ² to 129.0 cm ²)	+0.0035 (+0.089 mm)	+0.004 (+0.102 mm)	+0.004 (+0.102 mm)	+0.009 (+0.23 mm)
21 in ² to 50 in ² (135.5 cm ² to 322.6 cm ²)	+0.004 (+0.102 mm)	+0.005 (+0.153 mm)	+0.005 (+0.153 mm)	+0.010 (+0.25 mm)
51 in ² to 100 in ² (329.0 cm ² to 645.2 cm ²)	+0.006 (+0.153 mm)	+0.008 (+0.203 mm)	+0.008 (+0.203 mm)	—
101 in ² to 200 in ² (651.6 cm ² to 1290.3 cm ²)	+0.008 (+0.203 mm)	+0.012 (+0.305 mm)	+0.012 (+0.305 mm)	—
201 in ² to 300 in ² (1296.8 cm ² to 1935.5 cm ²)	+0.012 (+0.305 mm)	+0.016 (+0.406 mm)	+0.016 (+0.406 mm)	—

For projected area of die casting over 300 in² (1935.5 cm²), consult with your die caster.

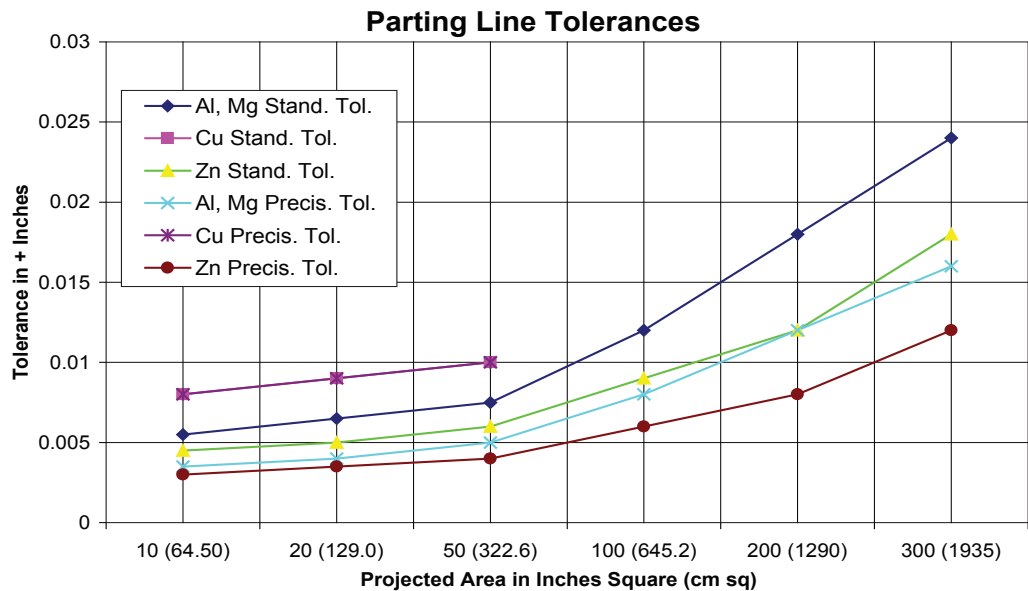

8 Moving Die Components (MDC): Standard Tolerances

Moving Die Components Tolerance can affect final part performance similar to Parting Line Tolerance. When the core is fully inserted into the die, the minimum tolerance is zero. As excess material and pressure are exerted in the die, the core can slide out creating an oversized condition. A MDC Tolerance has been developed to ensure minimal impact on form, fit and function by specifying limits to the oversize condition.

Similar to Parting Line Tolerance, MDC Standard Tolerance is a function of the Projected Area Tolerance plus Linear Tolerance. Linear Tolerance is calculated based on the length of movement of the core slide along dimension “ $E_3 E_1$ ”. Table S-4A-1 is used to determine Linear Tolerance. The linear dimension is not the entire length of “ $E_3 E_1$ ” but is only the length of the core slide from where the core slide first engages the die to its full insertion position. Linear dimension is normally perpendicular to the Projected Area.

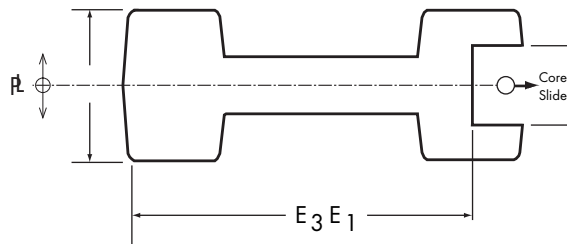

Projected Area is the area of the core head that faces the molten material. Projected Area Tolerance for moving die components is determined from table S-4A-3. The open area (cavity) on the end view of the part in figure 4A-1A at the beginning of this section shows the projected area. Projected Area Tolerance plus Linear Tolerance provide MDC Standard Tolerance for the volume of the part. Note that the tolerances in the table apply to a single casting regardless of the number of cavities.

Example: An aluminum casting has 75 in² (483.9 cm²) of Projected Area calculated from the core slide head facing the molten material. From table S-4A-3, Projected Area Tolerance is +0.024. This is combined with the length of the core slide Linear Tolerance from table S-4A-1 to obtain the MDC Standard Tolerance. The total core slide length of 5.00 in. (127 mm) is measured from where the core engages the part to full insertion in the plane of dimension “ $E_3 E_1$ ” to determine Linear Tolerance length. From table S-4A-1, the Linear Tolerance is ±0.010 for the first inch and ±0.001 for each of the four additional inches.

The Linear Tolerance of ±0.014 inches is combined with the Projected Area Tolerance of +0.024 to yield a MDC Standard Tolerance of +0.038/-0.014 in.

MDC Metric Standard Tolerance is +0.96/-0.35 mm = (±0.35 mm) + (+0.61 mm) on dimensions formed by moving die components.

Table S-4A-3 MDC Tolerances (Standard) – Added to Linear Tolerances

Projected Area of Die Casting inches ² (cm ²)	Die Casting Alloys (Tolerances shown are "plus" values only)			
	Zinc	Aluminum	Magnesium	Copper
up to 10 in ² (64.5 cm ²)	+0.006 (+0.15 mm)	+0.008 (+0.20 mm)	+0.008 (+0.20 mm)	+0.012 (+0.305 mm)
11 in ² to 20 in ² (71.0 cm ² to 129.0 cm ²)	+0.009 (+0.23 mm)	+0.013 (+0.33 mm)	+0.013 (+0.33 mm)	—
21 in ² to 50 in ² (135.5 cm ² to 322.6 cm ²)	+0.013 (+0.33 mm)	+0.019 (+0.48 mm)	+0.019 (+0.48 mm)	—
51 in ² to 100 in ² (329.0 cm ² to 645.2 cm ²)	+0.019 (+0.48 mm)	+0.024 (+0.61 mm)	+0.024 (+0.61 mm)	—
101 in ² to 200 in ² (651.6 cm ² to 1290.3 cm ²)	+0.026 (+0.66 mm)	+0.032 (+0.81 mm)	+0.032 (+0.81 mm)	—
201 in ² to 300 in ² (1296.8 cm ² to 1935.5 cm ²)	+0.032 (+0.81 mm)	+0.040 (+0.1 mm)	+0.040 (+0.1 mm)	—

For projected area of die casting over 300 in² (1935.5 cm²), consult with your die caster.

The values shown represent Standard Tolerances, or normal die casting production practice at the most economical level. For greater casting accuracy see Precision Tolerances for this characteristic on the facing page. Be sure to also address the procedures referred to in Section 7, “Quality Assurance,” sub-section 3, 4 and 5.

Die Shift:

Parting line die shift, unlike parting line separation and moving die component tolerances, is a left/right relationship with possible ± consequences. It can shift in four directions, based on a combination of part features, die construction and operation factors. It can occur at any time and its tolerance consequences should be discussed with the die caster at the design stage to minimize any impact on the final die casting.

Notes:

All values for part dimensions which run across the die parting line are stated as a “plus” tolerance only. The die casting die at a die closed position creates the bottom of the tolerance range, i.e., 0.000 (zero). Due to the nature of the die casting process, dies can separate imperceptibly at the parting line and create only a larger, or “plus” side, tolerance.

Precision Tolerance values shown represent greater casting accuracy involving extra precision in die construction and/or special control in production. They should be specified only when and where necessary, since additional costs may be involved. Be sure to also address the procedures referred to in Section 7, "Quality Assurance," sub-section 3, 4 and 5.

Methods for Improving Precision:

1. By repeated sampling and recutting of the die casting tool, along with production capability studies, even closer dimensions can be held—at additional sampling or other costs.
2. The die casting process may cause variations to occur in parting line separation. Thus, tolerances for dimensions that fall across the parting line on any given part should be checked in multiple locations, i.e., at four corners and on the center line.
3. In the case of extremely small zinc parts, weighing fractions of an ounce, special die casting machines can achieve significantly tighter tolerances, with zero draft and flash-free operation. See section 4B Miniature Die Casting.

Engineering & Design: Coordinate Dimensioning

Moving Die Components (MDC): Precision Tolerances

Precision Tolerances attainable on die cast dimensions such as "E₃ E₁" formed by a moving die component will be the linear tolerance from table P-4A-1 plus the value shown in table P-4A-3. Linear Tolerance is the length of the core slide. Projected Area is the area of the head of the core slide facing the molten material. The value chosen from table P-4A-3 depends on the Projected Area of the portion of the die casting formed by the moving die component (MDC) perpendicular to the direction of movement. Note that tolerances shown are plus side only.

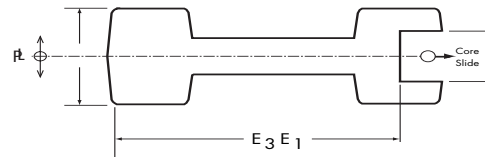

Example: An aluminum die casting has 75 in² (483.9 cm²) of Projected Area calculated from the core slide head facing the molten material. From table P-4A-3, Projected Area Tolerance is +0.018. This is combined with the length of the core slide Linear Tolerance from table P-4A-1 to obtain the MDC Precision Tolerance.

The total core slide length of 5.00 in. (127 mm) is measured from where the core engages the part to full insertion in the plane of dimension "E₃ E₁" to determine Linear Tolerance length from table P-4A-1, the Linear Tolerance is ±0.002 for the first inch and ±0.001 for each of the four additional inches. The Linear Tolerance of ±0.006 inches is combined with the Projected Area Tolerance of +0.018 to yield a MDC Precision Tolerance of +0.024/-0.006 in.

MDC Metric Precision Tolerance is +0.607/-0.15 mm = (±0.15 mm) +(0.457 mm) on dimensions formed by MDC.

Table P-4A-3 MDC Tolerances (Precision) – Added to Linear Tolerances

Projected Area of Die Casting inches ² (cm ²)	Die Casting Alloys (Tolerances shown are "plus" values only)			
	Zinc	Aluminum	Magnesium	Copper
up to 10 in ² (64.5 cm ²)	+0.005 (A) (+0.127 mm)	+0.006 (+0.152 mm)	+0.005 (+0.127 mm)	+0.010 (+0.254 mm)
11 in ² to 20 in ² (71.0 cm ² to 129.0 cm ²)	+0.007 (+0.178 mm)	+0.010 (+0.254 mm)	+0.007 (+0.178 mm)	—
21 in ² to 50 in ² (135.5 cm ² to 322.6 cm ²)	+0.010 (+0.254 mm)	+0.014 (+0.356 mm)	+0.010 (+0.254 mm)	—
51 in ² to 100 in ² (329.0 cm ² to 645.2 cm ²)	+0.014 (+0.356 mm)	+0.018 (+0.457 mm)	+0.014 (+0.356 mm)	—
101 in ² to 200 in ² (651.6 cm ² to 1290.3 cm ²)	+0.019 (+0.483 mm)	+0.024 (+0.61 mm)	+0.019 (+0.483 mm)	—
201 in ² to 300 in ² (1296.8 cm ² to 1935.5 cm ²)	+0.024 (+0.61 mm)	+0.030 (+0.762 mm)	+0.024 (+0.61 mm)	—

For projected area of die casting over 300 in² (1935.5 cm²), consult with your die caster.

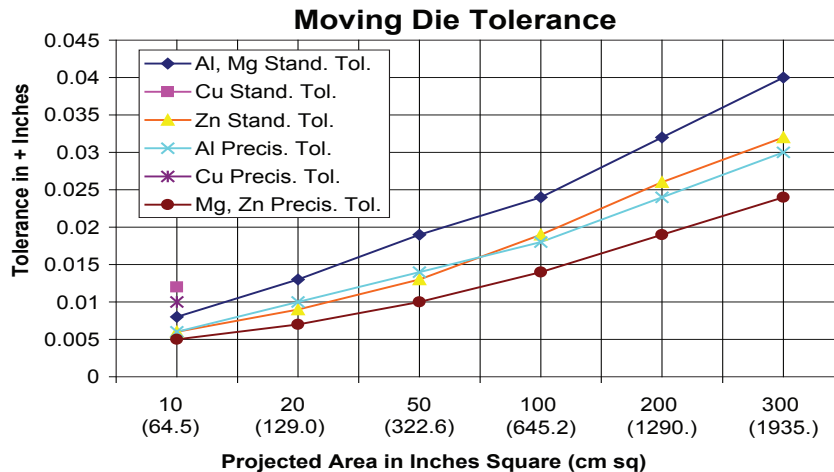

9 Angularity Tolerances (Plane surfaces): Standard & Precision Tolerances

Angularity refers to the angular departure from the designed relationship between elements of the die casting. Angularity includes, but is not limited to, flatness, parallelism and perpendicularity. The angular accuracy of a die casting is affected by numerous factors including size of the die casting, the strength and rigidity of the die casting and die parts under conditions of high heat and pressure, position of moving die components, and distortion during handling of the die casting. Angularity is not a stand alone tolerance. Angularity Tolerance is added to other part feature tolerances. For example, if determining tolerance for angular features at the Parting Line, Parting Line Tolerance and Angularity Tolerance would be added to yield total part tolerance.

Angularity is calculated from the following tables based on the surface length that is impacted by angularity and where the surface is located.

There are four tables for calculating Standard and Precision Angularity Tolerance. Table S/P-4A-4A provides Angularity Tolerance for features in the same die half. Table S/P-4A-4B provides Angularity Tolerance for features that cross the parting line. Table S/P-4A-4C provides Angularity Tolerance for MDC features that are in the same die half. Table S/P-4A-4D provides Angularity Tolerance for multiple MDC features or MDC features that cross the parting line. The more MDCs involved, the more tolerance is necessary hence multiple tables.

Applicability of Standard

This standard may be applied to plane surfaces of die castings for all alloys. Its tolerances are to be considered in addition to those provided by other standards.

Angularity Tolerances - All Alloys

Tolerances required vary with the length of the surface of the die casting and the relative location of these surfaces in the casting die.

Type	Surfaces 3" (76.2 mm) or less	Each 1" (25.4 mm) over 3" (76.2 mm)	
Standard	.005 (.13 mm)	.001 (.025 mm)	
Precision	.003 (.08 mm)	.001 (.025 mm)	

Fixed Angularity Tolerance Same Die Half

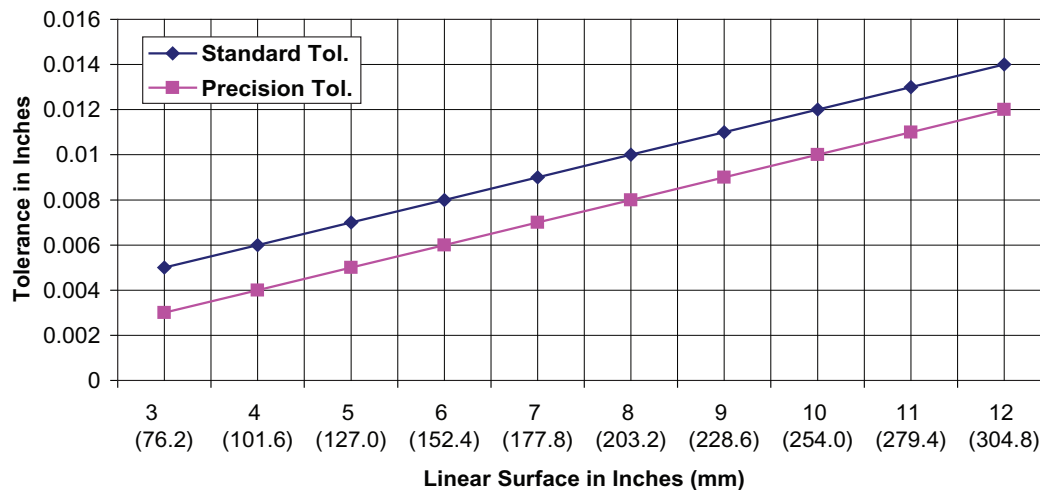

Standard Tolerances shown represent normal die casting production practice at the most economical level.

Precision Tolerance values shown represent greater casting accuracy involving extra precision in die construction and/or special control in production. They should be specified only when and where necessary, since additional costs may be involved.

Angularity Tolerances (Plane surfaces): Standard & Precision Tolerances

Precision Tolerance values shown represent greater casting accuracy involving extra precision in die construction and/or special control in production. They should be specified only when and where necessary, since additional costs may be involved.

Example: Standard Tolerances – Surface -B- and the datum plane -A- are formed by the same die half. If surface -B- is 5" (127 mm) long it will be parallel to the datum plane -A- within .007 (.18 mm). [.005 (.13 mm) for the first 3" (76.2 mm) and .002 (.05 mm) for the additional length.]

Example: Precision Tolerances – Surface -B- and the datum plane -A- are formed by the same die half. If surface -B- is 5" (127 mm) long it will be parallel to the datum plane -A- within .005 (.13 mm). [.003 (.08 mm) for the first 3" (76.2 mm) and .002 (.05 mm) for the additional length.]

Example: For Standard Tolerances – Surface -B- and the datum plane -A- are formed in opposite die sections. If surface -B- is 7" (177.8 mm) long it will be parallel to the datum plane -A- within .014 (.36 mm).

[.008 (.20 mm) for the first 3" (76.2 mm) and .006 (.15 mm) for the additional length.]

Example: For Precision Tolerances – Surface -B- and the datum plane -A- are formed in opposite die sections. If surface -B- is 7" (177.8 mm) long it will be parallel to the datum plane -A- within .009 (.23 mm).

[.005(.13 mm) for the first 3" (76.2 mm) and .004 (.10 mm) for the additional length.]

Methods for Improving Precision:

1. By repeated sampling and recutting of the die casting tool, along with production capability studies, even closer dimensions can be held—at additional sampling or other costs.
2. The die casting process may cause variations to occur in parting line separation. Thus, tolerances for dimensions that fall across the parting line on any given part should be checked in multiple locations, i.e., at four corners and on the center line.
3. In the case of extremely small zinc parts, weighing fractions of an ounce, special die casting machines can achieve significantly tighter tolerances, with zero draft and flash-free operation. See section 4B Miniature Die Casting.

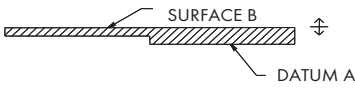
Type	Surfaces 3" (76.2 mm) or less	Each 1" (25.4 mm) over 3" (76.2 mm)	
Standard	.008 (.20 mm)	.0015 (.038 mm)	
Precision	.005 (.13 mm)	.001 (.025 mm)	

Fixed Angularity Tolerance Across PL

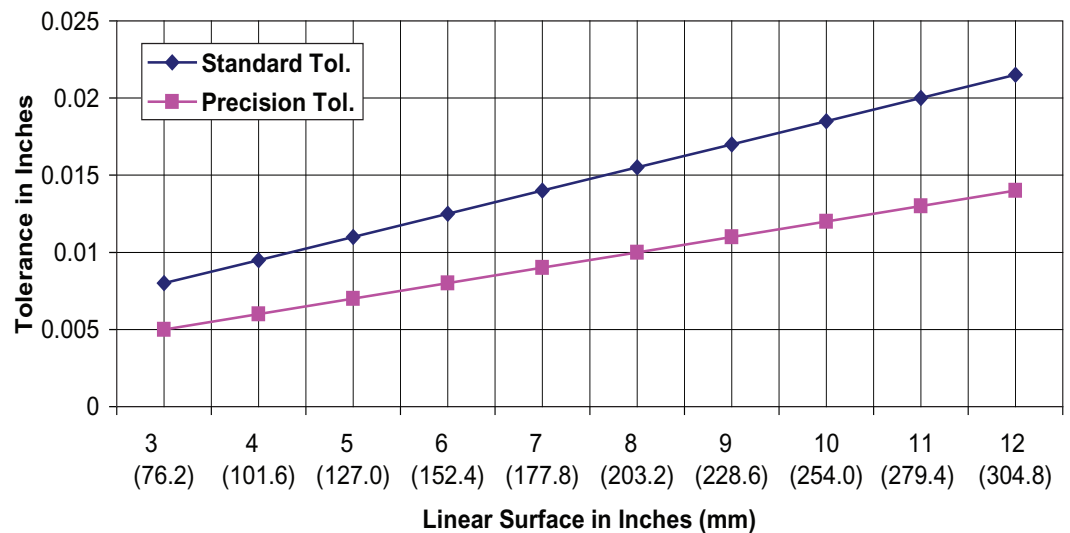

Angularity Tolerances (Plane surfaces): Standard & Precision Tolerances

Example: For Standard Tolerances – Surface -B- is formed by a moving die member in the same die section as datum plane -A-. If surface -B- is 5" (127 mm) long it will be perpendicular to the datum plane -A- within .011 (.28 mm).

[.008 (.20 mm) for the first 3" (76.2 mm) and .003 (.08 mm) for the additional length.]

Example: For Precision Tolerances – Surface -B- and the datum plane -A- are formed in opposite die sections. If surface -B- is 7" (177.8 mm) long it will be parallel to the datum plane -A- within .009 (.23 mm).

[.005(.13 mm) for the first 3" (76.2 mm) and .004 (.10 mm) for the additional length.]

Standard Tolerances shown represent normal die casting production practice at the most economical level.

Precision Tolerance values shown represent greater casting accuracy involving extra precision in die construction and/or special control in production. They should be specified only when and where necessary, since additional costs may be involved.

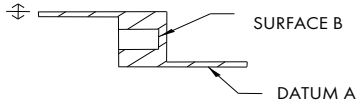
Type	Surfaces 3" (76.2 mm) or less	Each 1" (25.4 mm) over 3" (76.2 mm)	
Standard	.008 (.20 mm)	.0015 (.038 mm)	
Precision	.005 (.13 mm)	.001 (.025 mm)	

MDC Angularity Tolerance Same Die Half

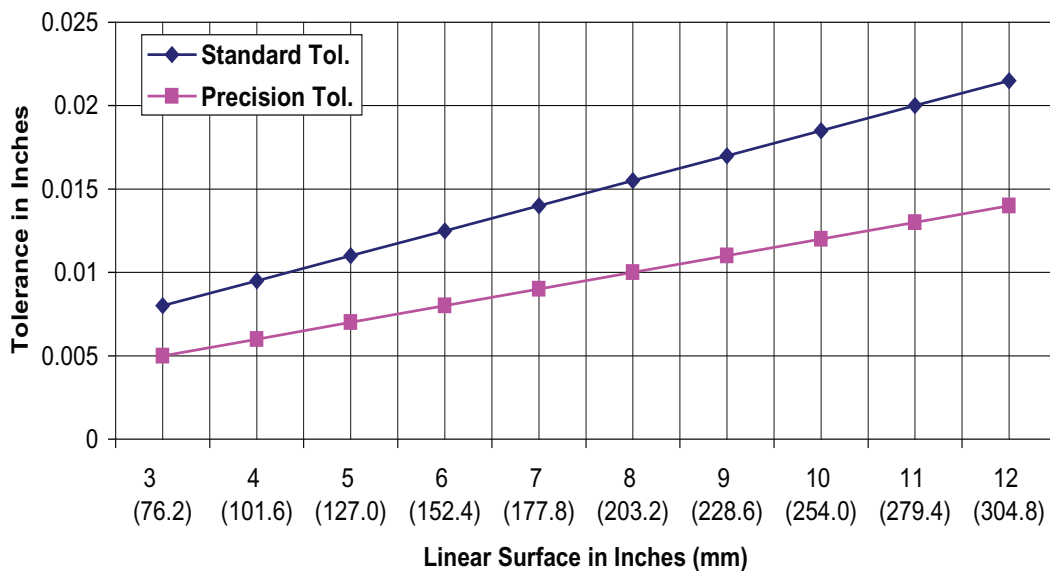

Angularity Tolerances (Plane surfaces): Standard & Precision Tolerances

Standard Tolerances shown represent normal die casting production practice at the most economical level.

Precision Tolerance values shown represent greater casting accuracy involving extra precision in die construction and/or special control in production. They should be specified only when and where necessary, since additional costs may be involved.

Example: For Standard Tolerances – Surface -B- is formed by a moving die member and the datum plane -A- is formed by the opposite die section. If surface -B- is 5" (127 mm) long it will be perpendicular to the datum plane -A- within .017 (.43 mm). [.011 (.28 mm) for the first 3" (76.2 mm) and .006 (.15 mm) for the additional length.]

Surfaces -B- and -C- are formed by two moving die members. If surface -B- is used as the datum plane and surface -B- is 5" (127 mm) long, surface -C- will be parallel to surface -B- within .017 (.43 mm).

[.011 (.28 mm) for the first 3" (76.2 mm) and .006 (.15 mm) for the additional length.]

Example: For Precision Tolerances – Surface -B- is formed by a moving die member and the datum plane -A- is formed by the opposite die section. If surface -B- is 5" (127 mm) long it will be perpendicular to the datum plane -A- within .012 (.30 mm). [.008 (.20 mm) for the first 3" (76.2 mm) and .004 (.10 mm) for the additional length.]

Surfaces -B- and -C- are formed by two moving die members. If surface -B- is used as the datum plane and surface -B- is 5" (127 mm) long, surface -C- will be parallel to surface -B- within .012 (.30 mm).

[.008 (.20 mm) for the first 3" (76.2 mm) and .004 (.10 mm) for the additional length.]

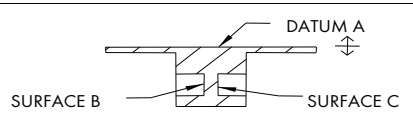
Type	Surfaces 3" (76.2 mm) or less	Each 1" (25.4 mm) over 3" (76.2 mm)	
Standard	.011 (.28 mm)	.003 (.076 mm)	
Precision	.008 (.20 mm)	.002 (.05 mm)	

MDC Angularity Tolerance Across Parting Line

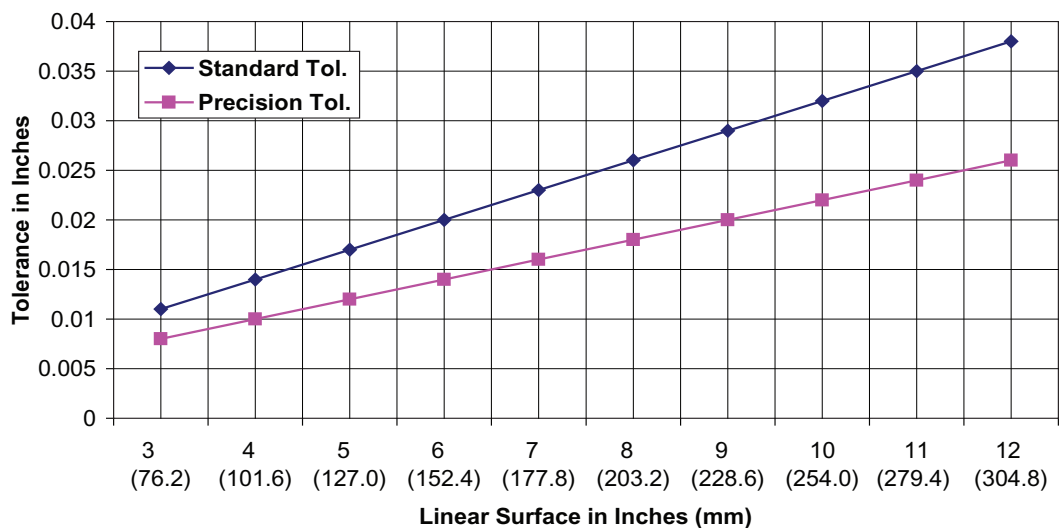

10 Concentricity Tolerances: Varying Degrees of Standard Tolerance

The concentricity of cylindrical surfaces is affected by the design of the die casting. Factors, such as casting size, wall thickness, shape, and complexity each have an effect on the concentricity of the measured surface. The tolerances shown below best apply to castings that are designed with uniformity of shape and wall thickness.

It should be noted that concentricity does not necessarily denote circularity (roundness). Part features can be considered concentric and still demonstrate an out of roundness condition. See section 5.11, Runout vs. Concentricity, in Geometric Dimensioning & Tolerancing for further explanation.

Concentricity Tolerance is added to other tolerances to determine maximum tolerance for the feature. For example, a concentric part that may cross the parting line, the tolerance would be the Concentricity Tolerance added to Parting Line Tolerance to give overall part tolerance. Note that the tolerances in the table apply to a single casting regardless of the number of cavities.

One Die Section

Concentricity Tolerance in a fixed relationship in one die section is calculated by selecting the largest feature diameter, (Diameter A) and calculating the tolerance from Table S-4A-5A using the chosen diameter. See information in the side column regarding selecting diameters for oval features. Selected diameter directly impacts degree of precision.

Example: Tolerance in One Die Section – An oval feature has a minimum diameter of 7 inches and a maximum diameter of 8 inches identified by the largest oval in the drawing below. This feature must fit into a hole with a high degree of precision. The minimum diameter (Diameter A) is chosen to give the highest degree of precision. From Table S-4A-5A, the basic tolerance for the first 3 inches is 0.008

inches (0.20 mm). 0.002 inches (0.05 mm) is added for each of the additional 4 inches to yield a total Concentricity Tolerance of +0.016 inches (+0.40 mm) for the 7" diameter.

Concentricity is defined as a feature having a common center and is usually round, circular or oval. Half the diameter is the center of the feature.

Standard and Precision Tolerance are not specified for Concentricity Tolerance since tolerance is determined from diameter.

As noted in the Concentricity Tolerance description, concentricity does not denote roundness. The feature may be oval and still be concentric. Therefore tolerance precision may be variable depending where diameter is measured.

If minimum diameter is chosen, the calculated tolerance from the table will be less indicating a higher degree of precision.

If maximum diameter is chosen, then calculated tolerance will be more indicating a more "standard" degree of precision.

Diameters chosen between minimum and maximum will determine varying degrees of precision.

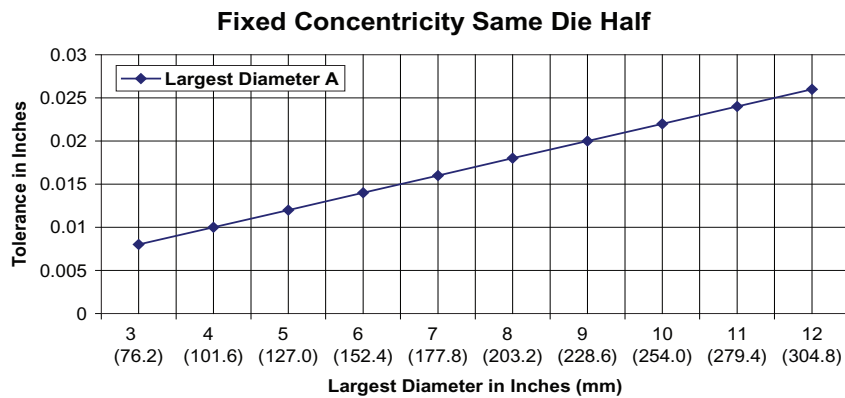
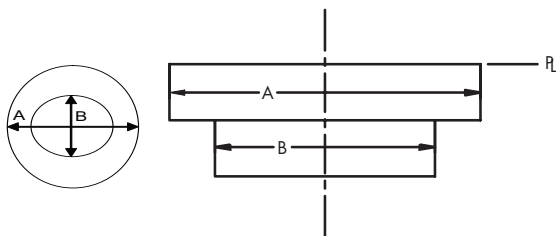

Table S-4A-5A: Concentricity Tolerance - Same Die Half (Add to other tolerances)

Surfaces in Fixed Relationship in One Die Section	
Diameter of Largest Diameter (A)	Tolerance (T.I.R.) inches (mm)
Basic Tolerance up to 3" (76.2mm)	.008 (.20 mm)
Additional Tolerance for each additional inch (25.4 mm) over 3" (76.2mm)	+ .002 (.05 mm)



Concentricity Tolerances: Varying Degrees of Standard Tolerance

Concentricity is defined as a feature having a common center and is usually round, circular or oval. Half the diameter is the center of the feature.

Standard and Precision Tolerance are not specified for Concentricity Tolerance since tolerance is determined from calculated area.

As noted in the Concentricity Tolerance description, concentricity does not denote roundness. The feature may be oval and still be concentric. Concentricity Tolerance precision is determined from chosen area and how the area is calculated.

Concentric Area Calculation

Round Features are those with equal diameter (D) regardless of where measured. Their area is calculated by:

$$(3.14) \times [(1/2 D)^2]$$

Oval Feature areas are determined by averaging the minimum and maximum diameters and then using the same formula as that for Round Features.

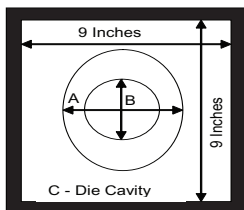

Opposite Die Halves

When concentric features are in opposite die halves, the area of the cavity at the parting line determines Concentricity Tolerance. If two concentric features meet at the parting line, it is the area of the larger feature that determines Concentricity Tolerance from table S-4A-5B. See the side column for determining the area of a concentric feature. As noted in the side column, degree of precision is determined from the calculated area when crossing the parting line.

If there is a cavity at the parting line between concentric features that are located in opposite die halves such as area C on the figure below, area of the cavity determines Concentricity Tolerance from table S-4A-5B.

Total part tolerance is the combination of Concentricity Tolerance plus other feature tolerances for the part.

Example: Tolerance in One Die Section – An oval feature has a minimum diameter of 6 inches and a maximum diameter of 8 inches identified as Diameter A. Diameter B is 5 inches. However, the area of cavity C is 9 by 9 inches. If concentric features meet at the parting line through the squared area C, Concentricity Tolerance is determined from table S-4A-5B by the 9 by 9 area which is 81 inches square. From table S-4A-5B the Concentricity Tolerance is +.012 inches (+.30 mm).

If concentric features meet at the parting line directly, the area of the larger oval is used to determine the Concentricity Tolerance from table S-4A-5B. For example, if the minimum diameter is 6 inches and the maximum diameter is 8 inches, the average diameter is 7 inches. Using the Concentricity Area Calculation

formula in the side column, the area is determined to be 38.5 inches square therefore the Concentricity Tolerance is +.008 inches (+.20 mm).

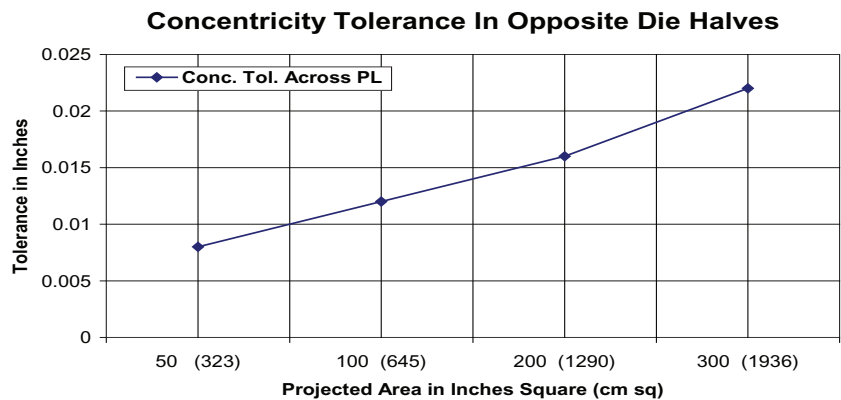
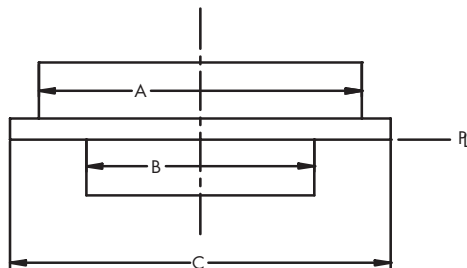

Table S-4A-5B: Concentricity Tolerance - Opposite Die Halves (Add to other tolerances)

Projected Area (C) of casting	Surfaces formed by Opposite Halves of Die (single cavity)	
	Additional Tolerance	inches (mm)
Up to 50 in ² (323 cm ²)	+ .008	(.20 mm)
51 in ² to 100 in ² (329 cm ² to 645 cm ²)	+ .012	(.30 mm)
101 in ² to 200 in ² (652 cm ² to 1290 cm ²)	+ .016	(.41 mm)
201 in ² to 300 in ² (1297 cm ² to 1936 cm ²)	+ .022	(.56 mm)



Parting Line Shift: Standard Tolerance

Parting line shift or die shift is a dimensional variation resulting from mismatch between the two die halves. The shift is a left/right type relationship that can occur in any direction parallel to the parting line of the two die halves. It has consequences to dimensions unlike parting line separation and moving die component tolerances. Parting line shift will influence dimensions that are measured across the parting line including concentricity of features formed by opposite die halves, and datum structures with datums in opposite die halves. Parting line shift compounds the affects of other tolerances measured across the parting line plane. Parting line shift can cause a part not to meet the requirements of form, fit and function.

Dies are designed and built with alignment systems to minimize parting line shift. However, effectiveness of alignment systems in minimizing parting line shift will depend on temperature variations, die construction, type of die and wear.

Variations in temperature between the two die halves of the die occur during the die's run. With die steel changing size with temperature variation, the two die halves will change size with respect to each other. To accommodate these changes in size, the alignment systems are designed with clearance to eliminate binding during opening and closing of the die. This clearance is necessary for the operation of the die but will allow a certain amount of parting line shift. One side of the die may be heated or cooled to compensate for temperature variation between die halves. One method to compensate for temperature variation is in the design and gating of the die. Another method is to apply additional die lube between shots to cool the hotter die half. Minimizing temperature variation between die halves allows for a more precise alignment system which will limit temperature induced parting line shift.

Moveable components (slides) within a die can also lead to parting line shift. Mechanical locks used to hold the slide in place during the injection of the metal can introduce a force that induces a parting line shift in the direction of the pull of the slide.

The type of die will also affect parting line shift. Due to their design for inter-changeability, unit dies will inherently experience greater parting line shift than full size dies. If parting line shift is deemed critical during part design, a full size die should be considered rather than a unit die.

Steps can be taken during the part design stage to minimize the impact of parting line shift. Datum structures should be set with all of the datum features in one half of the die. If this is not possible, additional tolerance may need to be added (see Geometric Dimensioning, Section 5). Another consideration during part design is to adjust parting lines so those features where mismatch is critical are cast in one half of the die.

Steps can also be taken during the die design to minimize parting line shift. Interlocks and guide blocks can be added to dies to improve alignment, but result in a higher maintenance tool. Placement of the cavities in the die can also be used to minimize the effect of mismatch between the two die halves.

Die wear and alignment system wear may impact parting line shift. As components wear, there is increasing lateral movement that will directly impact parting line shift. The method for decreasing wear induced parting line shift is to minimal moving parts when designing a die system, provide good cooling and lubrication, and have a good preventive maintenance program.

It is important to note that parting line shift can occur at any time and its tolerance consequences should be discussed with the die caster at the design stage to minimize its impact on the final die casting.

There are two components to calculate the affect of parting line shift on a part. The first component is to determine Parting Line Shift Projected Area Tolerance. Cavity area at the parting line is used to determine Projected Area Tolerance from table S-4A-6.

The second component is to determine Linear Tolerance. Linear Tolerance is obtained from table S/P-4A-1 which was discussed earlier in this section.

Parting Line Shift Projected Area Tolerance is added to the Linear Tolerance to obtain the volumetric affect of total Parting Line Shift Tolerance on the part.

Parting Line Shift Tolerance is added to other feature tolerances to determine overall part tolerance.

Note that the tolerances in the table apply to a single casting regardless of the number of cavities.

Parting Line Shift

Tolerances are specified as standard tolerances, only. If a higher degree of precision is required, the caster should be consulted for possible steps that can be taken.

Parting Line Shift Tolerance is only specified in Standard Tolerance because this is the lowest limit to meet the requirements of form, fit and function at the most economical value. Parting line variation has a compounding affect on feature tolerances across the parting line.

Parting Line Shift: Standard Tolerance

Example: Parting Line Shift Tolerance

The cavity area at the parting line is 75 inches squared. From Table S-4A-6, the Projected Area Parting Line Shift Tolerance is ± 0.006 (± 0.152 mm). This is added to the Linear Tolerance from table S/P-4A-1.

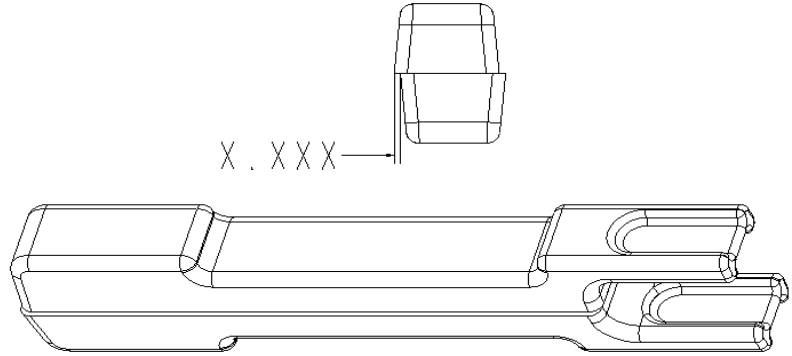
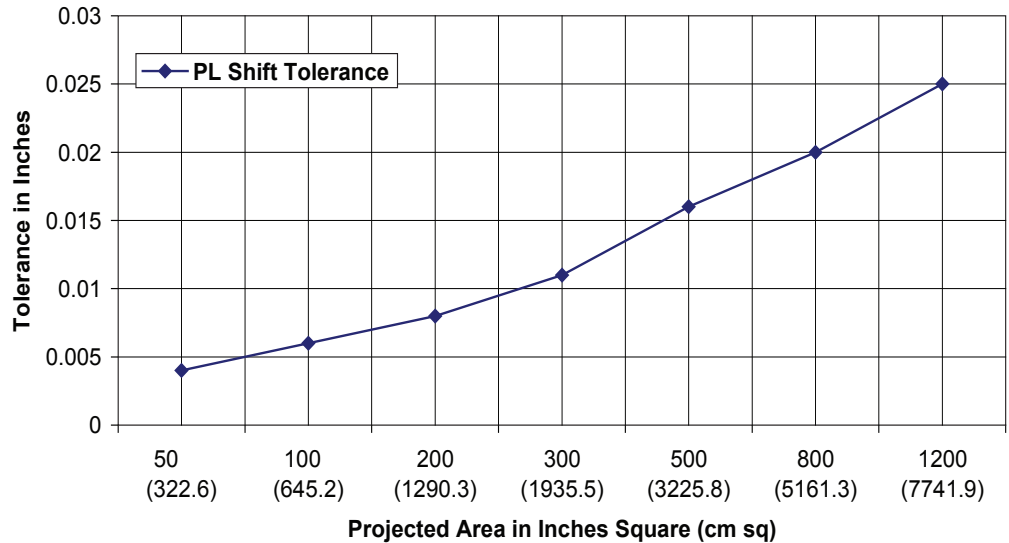

Table S-4A-6: Parting Line Shift Tolerance (Excluding unit dies)

Projected Area of Die Casting inches ² (cm ²)	Additional Tolerance inches (mm)
up to 50 in ² (322.6 cm ²)	± 0.004 (± 0.102 mm)
51 in ² to 100 in ² (329.0 cm ² to 645.2 cm ²)	± 0.006 (± 0.152 mm)
101 in ² to 200 in ² (651.6 cm ² to 1290.3 cm ²)	± 0.008 (± 0.203 mm)
201 in ² to 300 in ² (1296.8 cm ² to 1935.5 cm ²)	± 0.011 (± 0.279 mm)
301 in ² to 500 in ² (1941.9 cm ² to 3225.8 cm ²)	± 0.016 (± 0.406 mm)
501 in ² to 800 in ² (3232.3 cm ² to 5161.3 cm ²)	± 0.020 (± 0.508 mm)
801 in ² to 1200 in ² (5167.7 cm ² to 7741.9 cm ²)	± 0.025 (± 0.635 mm)

Parting Line Shift Tolerance



Draft Requirements: Standard Tolerances

Draft is the amount of taper or slope given to cores or other parts of the die cavity to permit easy ejection of the casting.

All die cast surfaces which are normally perpendicular to the parting line of the die require draft (taper) for proper ejection of the casting from the die. This draft requirement, expressed as an angle, is not constant. It will vary with the type of wall or surface specified, the depth of the surface and the alloy selected.

Draft values from the equations at right, using the illustration and the table below, provides Standard Draft Tolerances for draft on inside surfaces, outside surfaces and holes, achievable under normal production conditions.

Draft Example (Standard Tolerances):

In the case of an inside surface for an aluminum cast part, for which the constant “C” is 30 (6 mm), the recommended Standard Draft at three depths is:

Depth	Draft Distance	Draft Angle
in. (mm)	in. (mm)	Degrees
0.1 (2.50)	0.010 (0.250)	6°
1.0 (25)	0.033 (0.840)	1.9°
5.0 (127)	0.075 (1.890)	0.85°

To achieve lesser draft than normal production allows, Precision Tolerances maybe specified (see opposite page).

Calculation for Draft Distance

$$D = \frac{\sqrt{L}}{C}$$

Calculation for Draft Angle

$$A = \frac{\left(\frac{D}{L}\right)}{0.01746} \quad \text{or} \quad \frac{57.2738}{C\sqrt{L}}$$

Where: D= Draft in inches
 L= Depth or height of feature from the parting line
 C= Constant, from table S-4A-7, is based on the type of feature and the die casting alloy
 A= Draft angle in degrees Draft

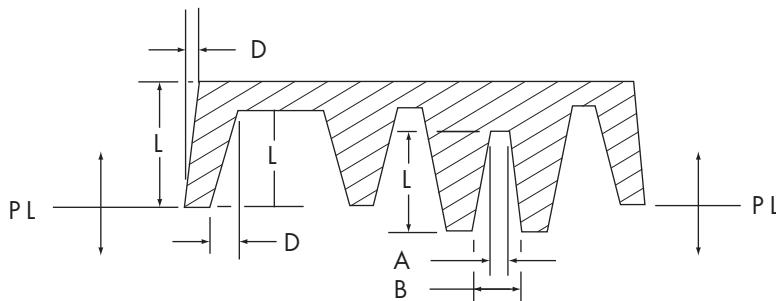

Drawing defines draft dimensions for interior and exterior surfaces and total draft for holes (draft is exaggerated for illustration).

The formula for draft shown here represents Standard Tolerance, or normal casting production practice at the most economical level. For Precision Tolerance for draft, see the facing page.

Note:

As the formula indicates, draft, expressed as an angle, decreases as the depth of the feature increases. Twice as much draft is recommended for inside walls or surfaces as for outside walls/surfaces. This provision is required because as the alloy solidifies it shrinks onto the die features that form inside surfaces (usually located in the ejector half and away from features that form outside surfaces (usually located in the cover half). Note also that the resulting draft calculation does not apply to cast lettering, logotypes or engraving. Such elements must be examined individually as to style, size and depth desired. Draft requirements need to be discussed with the die caster prior to die design for satisfactory results.

(Used automatic equation solve on “advanced solve page” at: <http://www.quickmath.com/www.2/pages/modules/equations>)

Engineering & Design: Coordinate Dimensioning

Draft Requirements: Standard Tolerances

Table S-4A-7: Draft Constants for Calculating Draft and Draft Angle

Values of Constant "C" by Features and Depth (Standard Tolerances)

Alloy	Inside Wall For Dim. in inches (mm)	Outside Wall For Dim. in inches (mm)	Hole, Total Draft for Dim. in inches (mm)
Zinc/ZA	50 (9.90 mm)	100 (19.80 mm)	34 (6.75 mm)
Aluminum	30 (6.00 mm)	60 (12.00 mm)	20 (4.68 mm)
Magnesium	35 (7.00 mm)	70 (14.00 mm)	24 (4.76 mm)
Copper	25 (4.90 mm)	50 (9.90 mm)	17 (3.33 mm)

It is not common practice to specify draft separately for each feature. Draft is normally specified by a general note with exceptions called out for individual features. The formula should be used to establish general draft requirements with any exceptions identified.

For example, the results at the left indicate that an aluminum casting with most features at least 1.0 in. deep can be covered with a general note indicating 2° minimum draft on inside surfaces and 1° minimum on outside surfaces (based on outside surfaces requiring half as much draft).

Precision Tolerances for draft resulting from the calculations outlined here involve extra precision in die construction and/or special control in production. They should be specified only when necessary. Draft or the lack of draft can greatly affect castability. Early die caster consultation will aid in designing for minimum draft, yet sufficient draft for castability.

Note:

As the formula indicates, draft, expressed as an angle, decreases as the depth of the feature increases. See graphical representation on the following pages for various alloys. Twice as much draft is recommended for inside walls or surfaces as for outside walls/surfaces. This provision is required because as the alloy solidifies it shrinks onto the die features that form inside surfaces (usually located in the ejector half) and away from features that form outside surfaces (usually located in the cover half). Note also that the resulting draft calculation does not apply to die cast lettering, logotypes or engraving. Such elements must be examined individually as to style, size and depth desired. Draft requirements need to be discussed with the die caster prior to die design for satisfactory results.

Draft Requirements: Precision Tolerances

All cast surfaces normally perpendicular to the parting line of the die require draft (taper) for proper ejection of the casting from the die. Minimum precision draft for inside walls is generally recommended at 3/4 degrees per side; with outside walls requiring half as much draft.

Draft values from the equation at right, using the illustration and the table below, estimate specific Precision Draft Tolerances for draft on inside surfaces, outside surfaces and holes. Precision Draft Tolerances will vary with the type of wall or surface specified, the depth of the wall, and the alloy selected.

Draft Example (Precision Tolerances):

In the case of an inside surface for an aluminum cast part, for which the constant “C” is 40 (7.80 mm), the recommended Precision Draft at three depths is:

Depth	Draft Distance	Draft Angle
in. (mm)	in. (mm)	Degrees
0.1 (2.50)	0.006 (0.150)	3.6°
1.0 (25)	0.020 (0.510)	1.1°
2.5 (63.50)	0.032 (1.140)	0.72°

Calculation for Draft Distance

$$D = \frac{\sqrt{L} \times 0.8}{C}$$

Calculation for Draft Angle

$$A = \frac{\left(\frac{D}{L}\right)}{0.01746} \quad \text{or} \quad \frac{45.819}{C\sqrt{L}}$$

To achieve lesser draft than normal production allows, Precision Tolerances maybe specified (see opposite page).

- Where:**
- D= Draft in inches
 - L= Depth or height of feature from the parting line
 - C= Constant, from table S-4A-7, is based on the type of feature and the die casting alloy
 - A= Draft angle in degrees

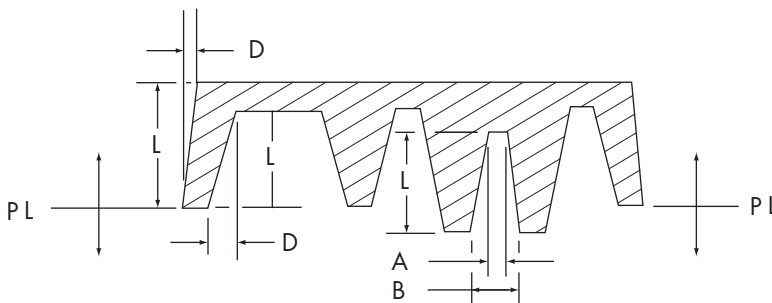

Drawing defines draft dimensions for interior and exterior surfaces and total draft for holes (draft is exaggerated for illustration).

(Used automatic equation solve on “advanced solve page” at: <http://www.quickmath.com/www.2/pages/modules/equations>)

Engineering & Design: Coordinate Dimensioning

Draft Requirements: Precision Tolerances

Table P-4A-7: Draft Constants for Calculating Draft and Draft Angle

Values of Constant "C" by Features and Depth (Precision Tolerances)

Alloy	Inside Wall For Dim. in inches (mm)	Outside Wall For Dim. in inches (mm)	Hole, Total Draft For Dim. in inches (mm)
Zinc/ZA	60 (12.00 mm)	120 (24.00 mm)	40 (7.80 mm)
Al/Mg/Cu	40 (7.80 mm)	80 (15.60 mm)	28 (5.30 mm)

It is not common practice to specify draft separately for each feature. Draft is normally specified by a general note with exceptions called out for individual features. The formula should be used to establish general draft requirements with any exceptions identified.

For example, the results at the left indicate that an aluminum casting with most features at least 1.0 in. deep can be covered with a general note indicating 1° minimum draft on inside surfaces and 0.5° minimum on outside surfaces (based on outside surfaces requiring half as much draft).

Aluminum Draft

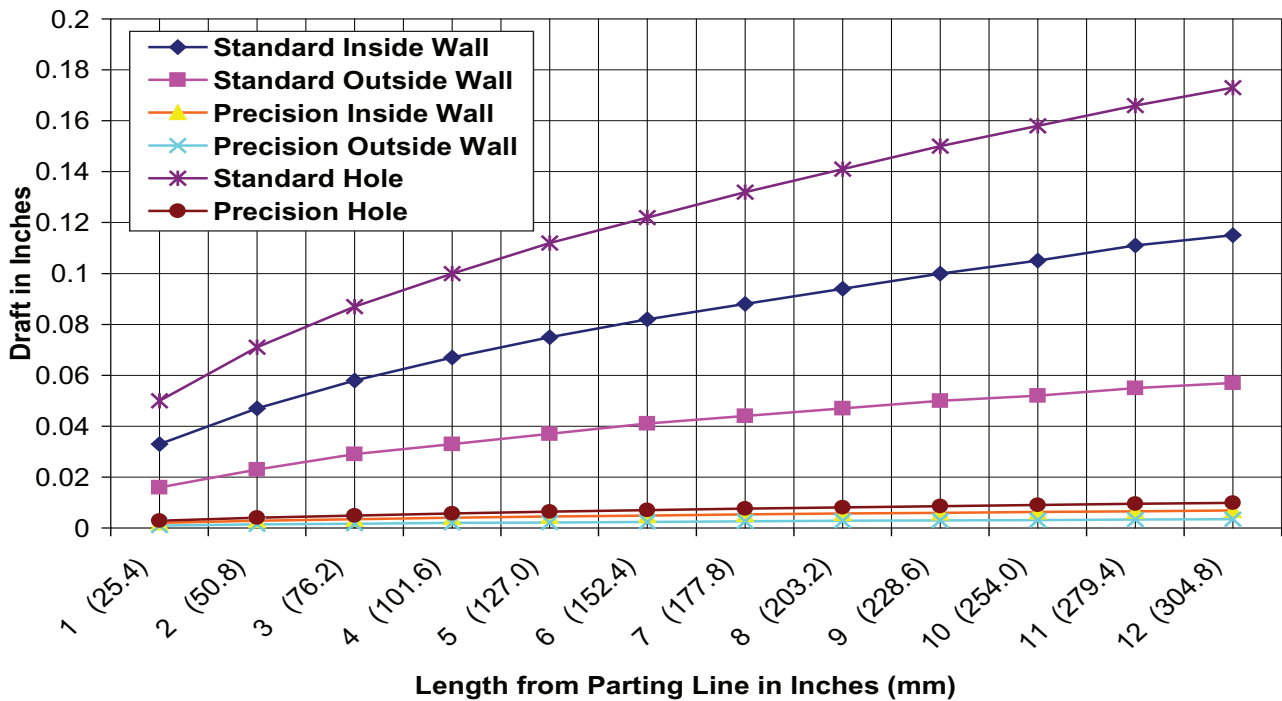

4A

Aluminum Draft Angle

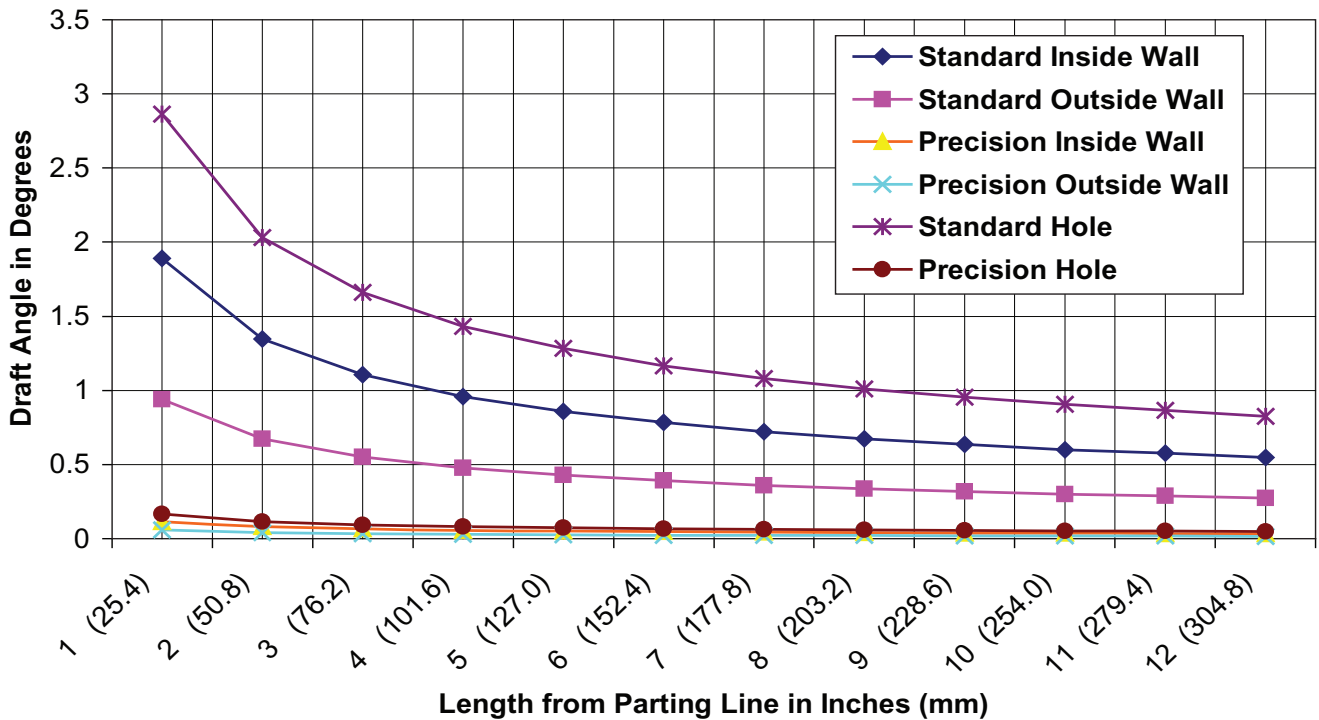

Copper Draft

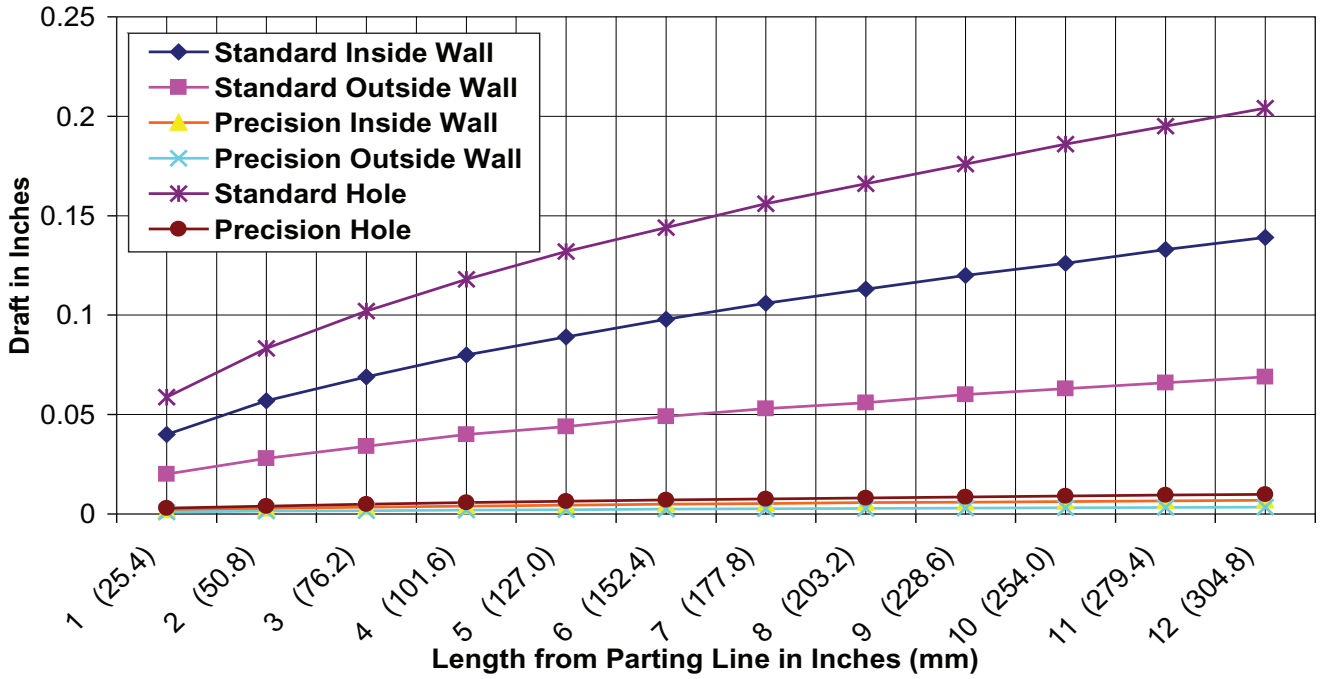

Copper Draft Angle

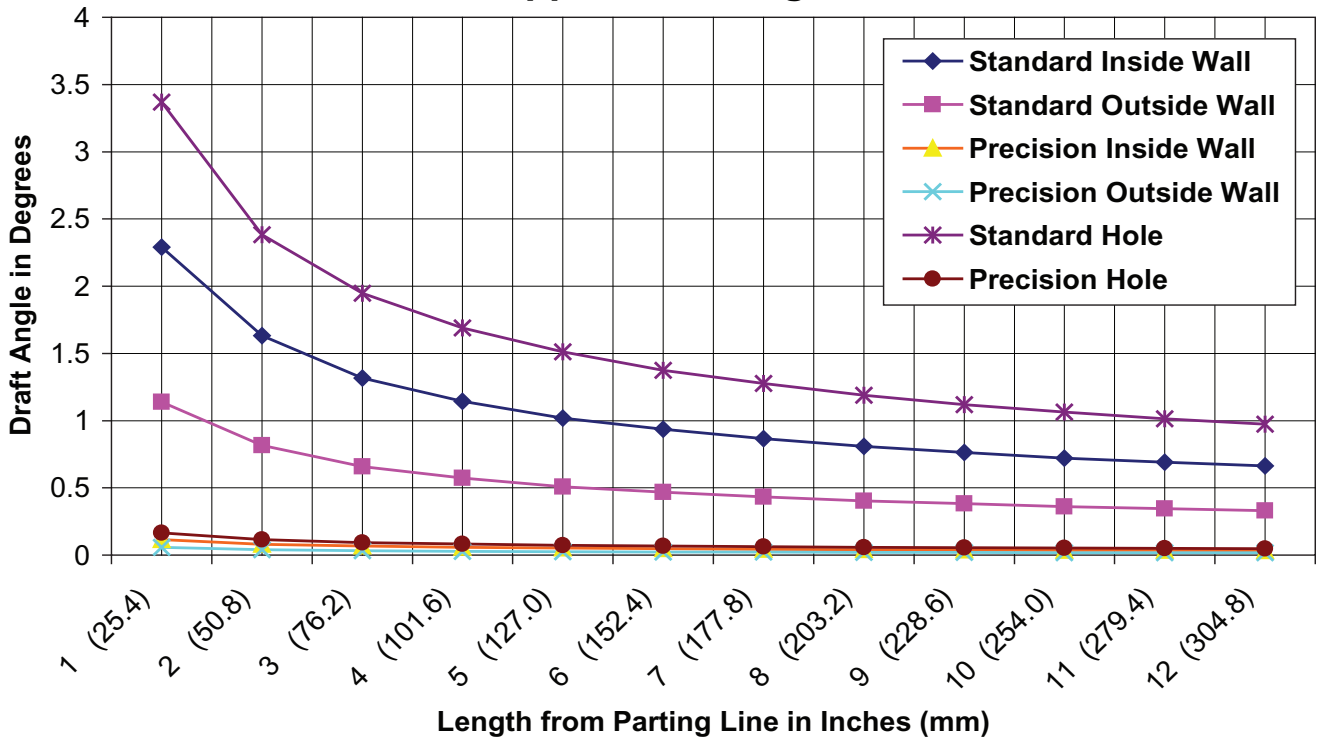

Magnesium Draft

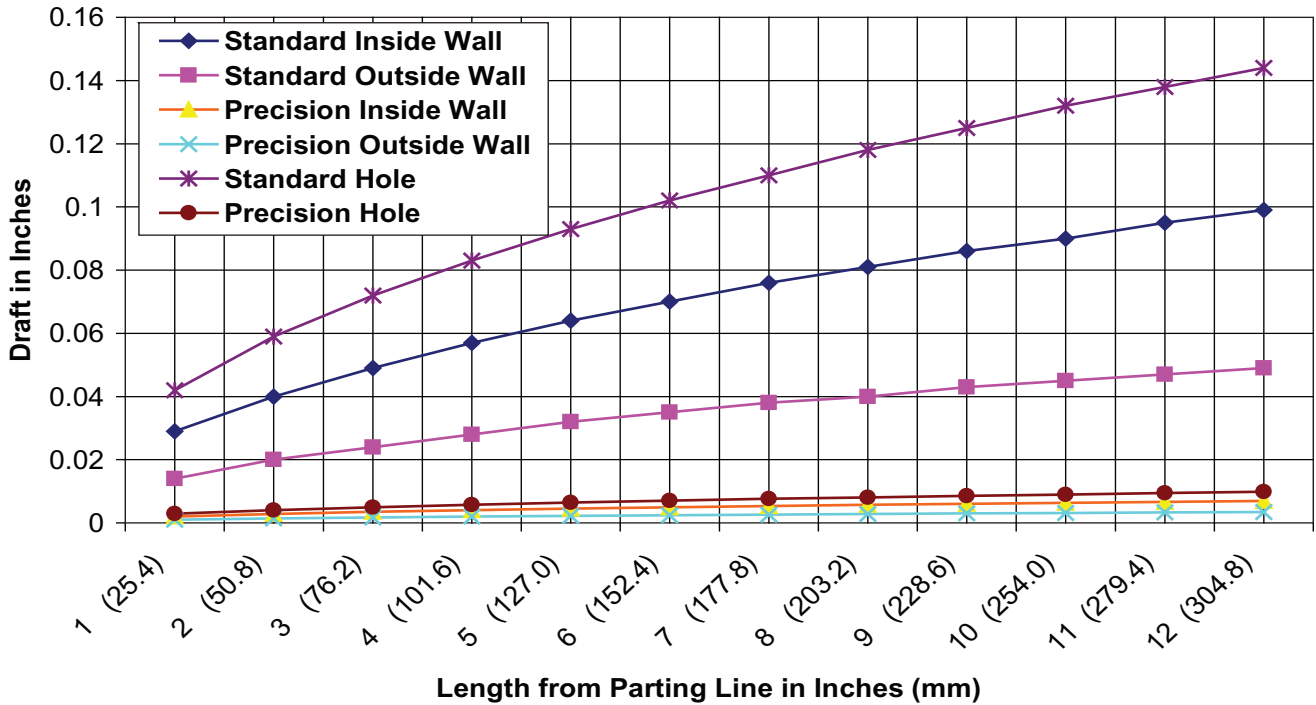

4A

Magnesium Draft Angle

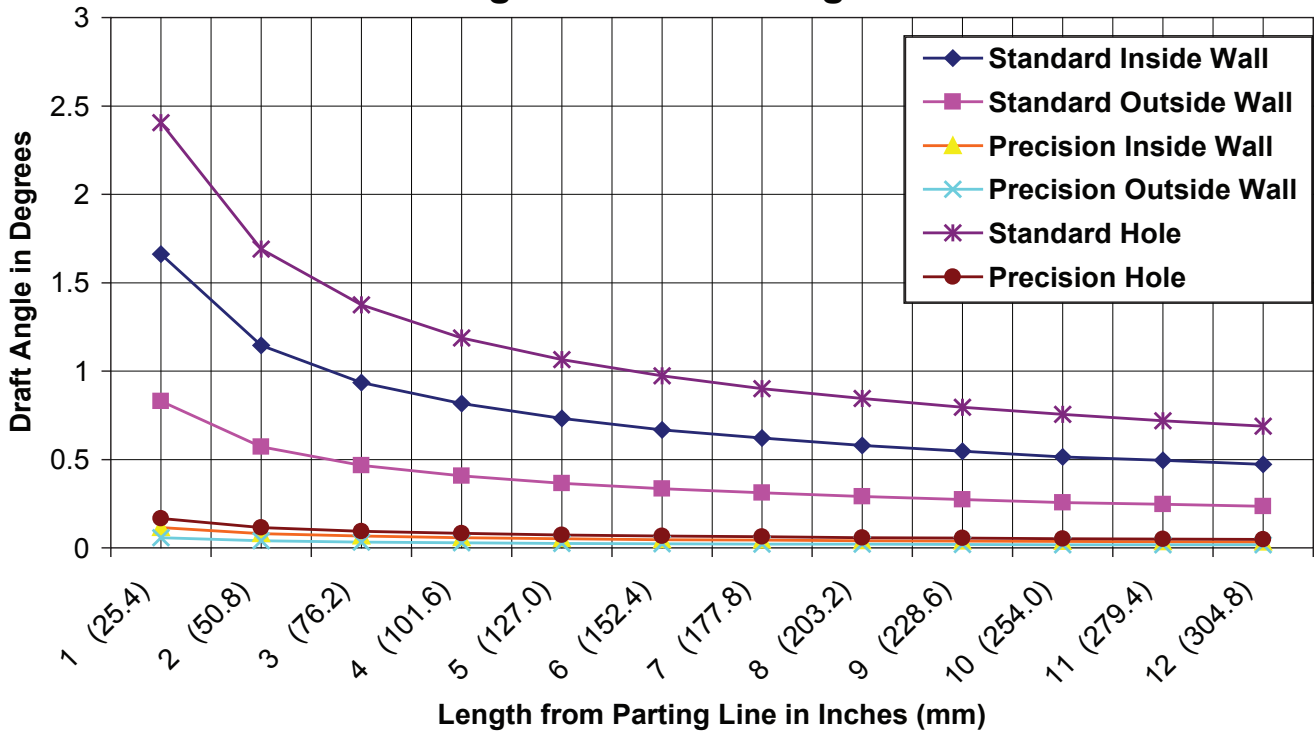

Zinc Draft

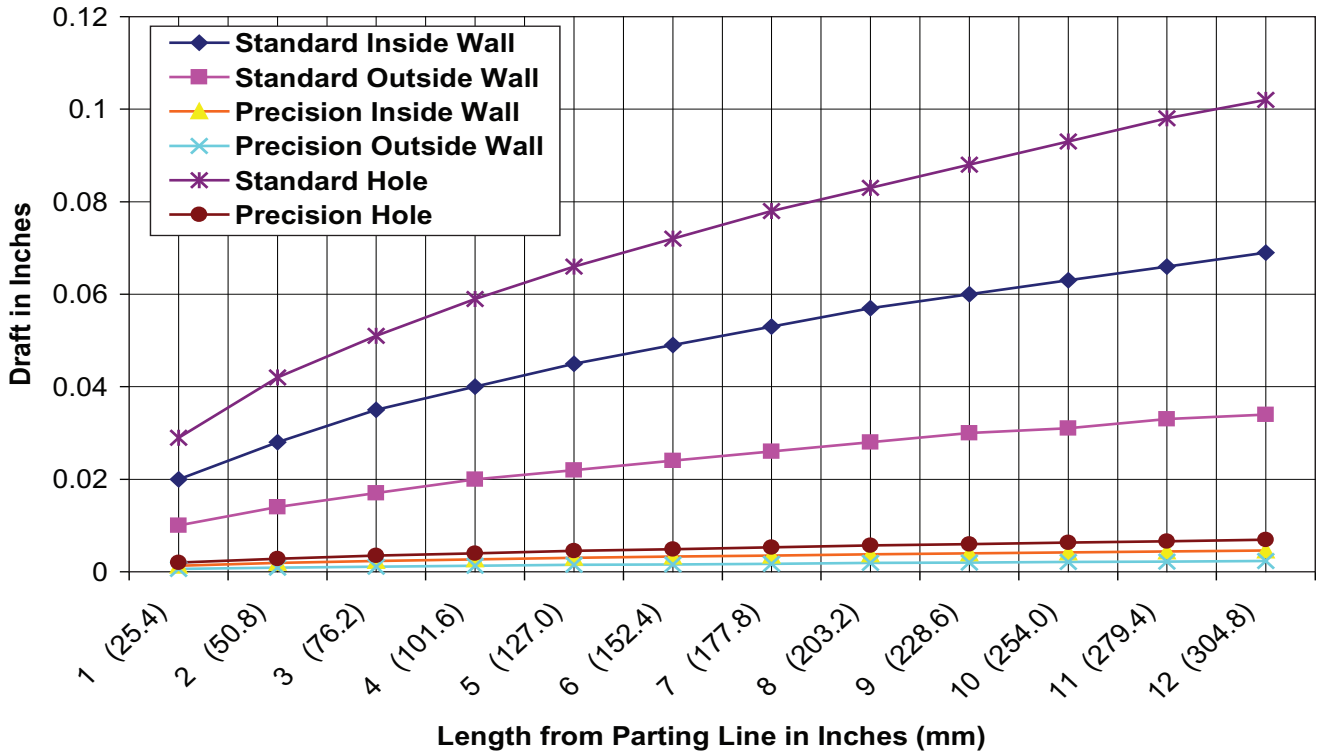

Zinc Draft Angle

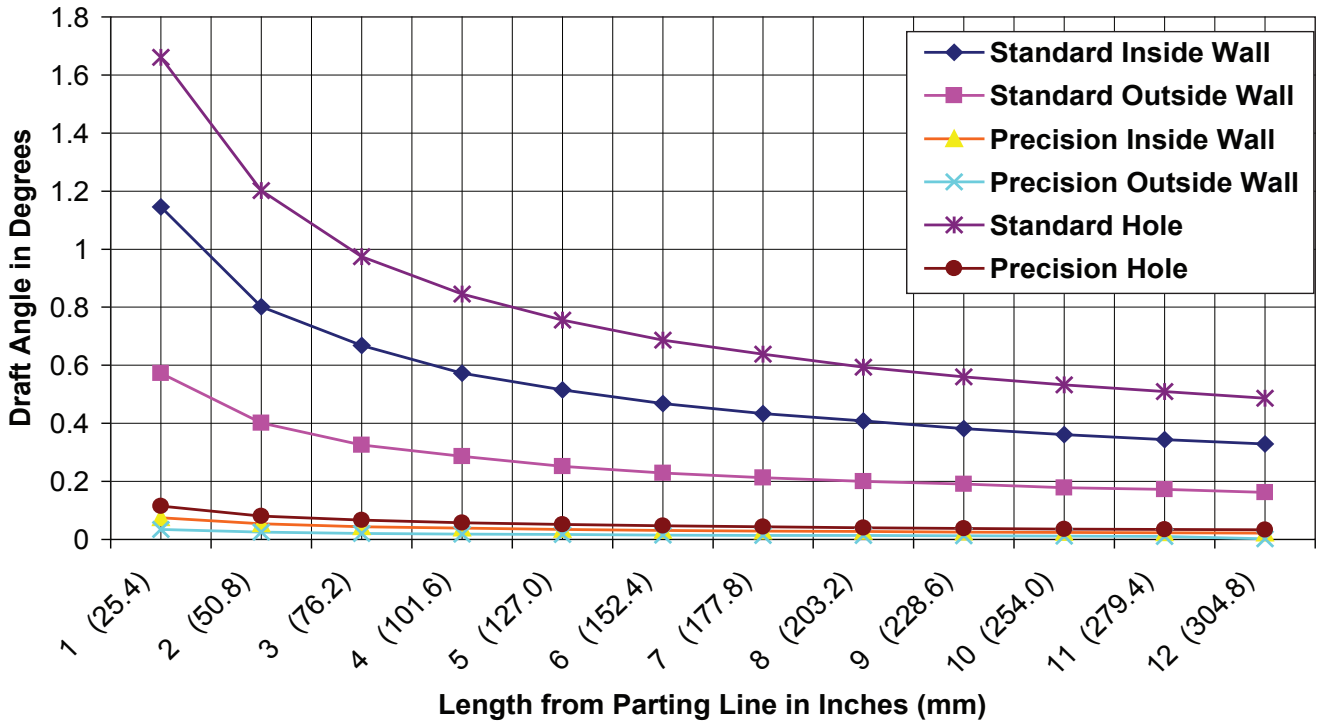

The flatness values shown here represent Standard Tolerances, or normal casting production practice at the most economical level. For greater casting accuracy see Precision Tolerances for this characteristic on the facing page.

Flatness is described in detail in Section 5, Geometric Dimensioning & Tolerancing. Simply put, Flatness Tolerance is the amount of allowable surface variation between two parallel planes which define the tolerance zone. See the figures below.

Flatness of a continuous plane surface on a casting should be measured by a method mutually agreed upon by the designer, die caster and the customer before the start of die design.

Note:
The maximum linear dimension is the diameter of a circular surface or the diagonal of a rectangular surface.

Flatness Design Guidelines:

1. All draft on walls, bosses and fins surrounding and underneath flat surfaces should be standard draft or greater.
2. Large bosses or cross sections can cause sinks and shrinkage distortions and should be avoided directly beneath flat surfaces.
3. Changes in cross section should be gradual and well filleted to avoid stress and shrinkage distortions.
4. Symmetry is important to obtain flatness. Lobes, legs, bosses and variations in wall height can all affect flatness.

Flatness Requirements: Standard Tolerance

Flatness defines surface condition not part thickness. See the flatness explanation on the opposite page.

Standard Tolerance is calculated using the largest dimensions defining the area where the tolerance is to be applied. If flatness is to be determined for a circular surface such as the top of a can, the largest dimension is the diameter of the can. If flatness is to be determined for a rectangular area, the largest dimension is a diagonal.

For greater accuracy, see Precision Tolerances for flatness on the opposite page.

Example: Flatness Tolerance - Diagonal

For a part where the diagonal measures 10 inches (254 mm), the maximum Flatness Standard Tolerance from table S-4A-8 is 0.008 inches (0.20 mm) for the first three inches (76.2 mm) plus 0.003 inches (0.08 mm) for each of the additional seven inches for a total Flatness Standard Tolerance of 0.029 inches (0.76 mm).

Maximum Dimension of Die Cast Surface	Tolerance inches (mm)
up to 3.00 in. (76.20 mm)	0.008 (0.20 mm)
Additional tolerance, in. (25.4 mm) for each additional in. (25.4 mm)	0.003 (0.08 mm)

Flatness Example

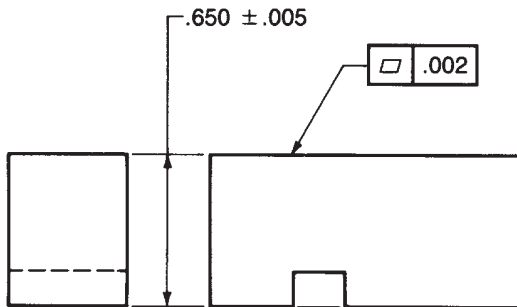

Explanation

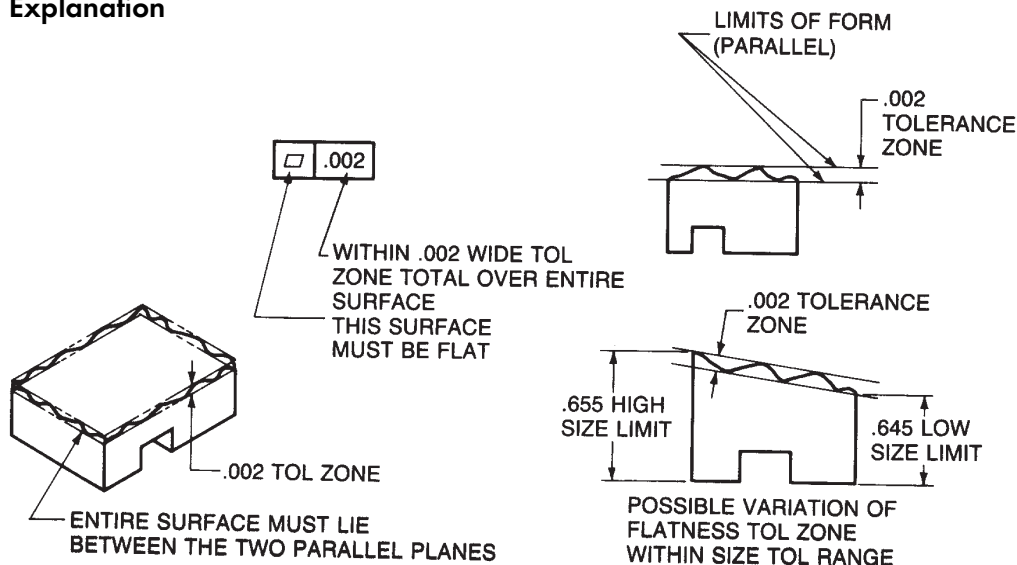

Engineering & Design: Coordinate Dimensioning

Flatness Requirements: Precision Tolerance

Precision Tolerance values for flatness shown represent greater casting accuracy involving extra precision in die construction. They should be specified only when and where necessary since additional cost may be involved.

The values shown for Precision Tolerance for flatness represent greater casting accuracy involving extra steps in die construction and additional controls in production. They should be specified only when and where necessary since additional costs may be involved.

Even closer tolerances may be held by working with the die caster to identify critical zones of flatness. These areas may be amenable to special die construction to help maintain flatness.

Flatness Explanation

As noted in the explanation diagram, flatness is independent of all other tolerance features including thickness.

Part thickness has a nominal thickness of 0.300 ± 0.010 . Flatness Tolerance is 0.005. Therefore at the high limit thickness the part surface flatness can be between 0.305 and 0.310 nominal thickness flatness can be between 0.300 and 0.305. Low limit thickness flatness can be between 0.290 and 0.295. Flatness can not range between 0.290 and 0.310. Using both high and low thickness in combination with flatness defeats the purpose for specifying flatness.

Notes:

The maximum linear dimension is the diameter of a circular surface or the diagonal of a rectangular surface.

Flatness Design Guidelines:

1. All draft on walls, bosses and fins surrounding and underneath flat surfaces should be standard draft or greater.
2. Large bosses or cross sections can cause sinks and shrinkage distortions and should be avoided directly beneath flat surfaces.
3. Changes in cross section should be gradual and well filleted to avoid stress and shrinkage distortions.
4. Symmetry is important to obtain flatness. Lobes, legs, bosses and variations in wall height can all affect flatness.

Example: Flatness Tolerance - Diagonal

For a part where the diagonal measures 10 inches (254 mm), the maximum Flatness Precision Tolerance from table P-4A-8 is 0.005 inches (0.13 mm) for the first three inches (76.2 mm) plus 0.002 inches (0.05 mm) for each of the additional seven inches for a total Flatness Standard Tolerance of 0.019 inches (0.48 mm).

Maximum Dimension of Die Cast Surface	Tolerance inches (mm)
up to 3.00 in. (76.20 mm)	0.005 (0.13 mm)
Additional tolerance, in. (25.4 mm) for each additional in. (25.4 mm)	0.002 (0.05 mm)

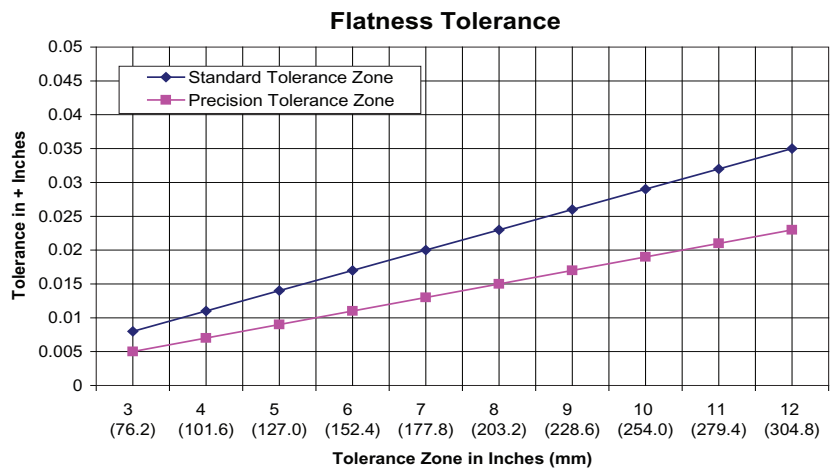

Explanation

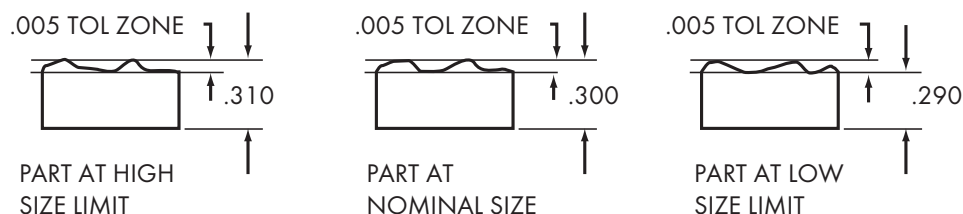

Design Recommendations: Cored Holes As-Cast

Cored holes in die castings can be categorized according to their function. There are three major classifications.

- Metal savers
- Clearance holes
- Function/locating holes

Each of these functions implies a level of precision. Metal savers require the least precision; function/locating holes require the greatest precision. Leaving clearance holes in-between.

Specifications for cored holes are the combination of form, size and location dimensions and tolerances required to define the hole or opening.

Metal Savers

Metal savers are cored features, round or irregular, blind or through the casting, whose primary purpose is to eliminate or minimize the use of raw material (metal/alloy). The design objective of the metal saver is to reduce material consumption, while maintaining uniform wall thickness, good metal flow characteristics, good die life characteristics with minimal tool maintenance.

Design recommendation:

1. Wall thickness

Design for uniform wall thickness around metal savers. Try to maintain wall thickness within $\pm 10\%$ of the most typical wall section.

2. Draft

Use draft per NADCA S-4A-7 for inside walls. Keep walls as parallel as practical.

3. Radii/fillets

Use as large a radius as possible, consistent with uniform wall thickness. Refer to NADCA guidelines G-6-2. Consider 0.06 inch radius (1.5 mm radius.) as a minimum. A generous radius at transitions and section changes will promote efficient metal flow during cavity filling.

Clearance Holes

Clearance holes are cored holes, round or irregular, blind or through the casting, whose primary purpose is to provide clearance for features and components. Clearance implies that location of the feature is important.

Design recommendation:

1. Tolerance

Dimensions locating the cored hole should be per NADCA Standard tolerances; S-4A-1 Linear Dimension, S-4A-2 Parting Line Dimensions and S-4A-3 Moving Die Components.

2. Wall thickness

Design for uniform wall thickness around metal savers. Try to maintain wall thickness within $\pm 10\%$ of the most typical wall section. If hole is a through hole, allowance should be made for any trim edge per NADCA G-6-5, Commercial Trimming within 0.015 in. (0.4 mm).

3. Draft

Use draft per NADCA S-4A-3 for inside walls. Keep walls as parallel as practical.

4. Radii/fillets

Use as large a radius as possible, consistent with uniform wall thickness. Refer to NADCA guidelines G-6-2. Consider 0.06 inch radius (1.5 mm radius.) as a minimum. A generous radius at transitions and section changes will promote efficient metal flow during cavity filling.

Engineering & Design: Coordinate Dimensioning

For holes with less than a 0.25 inch diameter, wall stock should be a minimum of one half the hole diameter.

For holes with larger than a 0.25 inch diameter, the wall stock shall be the nominal wall thickness (subject to part design).

Functional/Locating Holes

Functional/locating holes are cored holes whose purpose is to provide for a functional purpose such as threading, inserting and machining or location and alignment for mating parts or secondary operations.

Design recommendation:

1. Tolerance

Dimensions locating the cored hole to be per NADCA Precision tolerances; P-4A-1 Linear Dimension, P-4A-2 Parting Line Dimensions and P-4A-3 Moving Die Components.

2. Wall thickness

Design for uniform wall thickness around metal savers. Try to maintain wall thickness within $\pm 10\%$ of the most typical wall section. If hole is a through hole, allowance should be made for any trim edge per NADCA G-6-5, Commercial Trimming within 0.015 inch (0.4 mm) or if this is not acceptable, a mutually agreed upon requirement.

3. Draft

Use draft per NADCA P-4A-7 for inside walls. Keep walls as parallel as practical.

4. Radii/fillets

Use as large a radius as possible, consistent with uniform wall thickness. Refer to NADCA guidelines G-6-2. Consider 0.03 inch radius (0.8 mm radius.) as a minimum. A generous radius at transitions and section changes will promote efficient metal flow during cavity filling.

Other Design Considerations

Hole depths

Diameter of Hole – Inches									
	1/8	5/32	3/16	1/4	3/8	1/2	5/8	3/4	1
Alloy	Maximum Depth – Inches								
Zinc*	3/8	9/16	3/4	1	1-1/2	2	3-1/8	4-1/2	6
Aluminum*	5/16	1/2	5/8	1	1-1/2	2	3-1/8	4-1/2	6
Magnesium*	5/16	1/2	5/8	1	1-1/2	2	3-1/8	4-1/2	6
Copper				1/2	1	1-1/4	2	2-1/2	5

Note:

The depths shown are not applicable under conditions where small diameter cores are widely spaced and, by design, are subject to full shrinkage stress.

Perpendicularity

See Section 5 pages 5-19 and 5-20 Orientations Tolerances.

The values shown represent Standard Tolerances, or normal casting production practice at the most economical level. For greater casting accuracy see Precision Tolerances for the characteristic on the facing page.

Cored Holes for Cut Threads: Standard Tolerances

Cored holes for cut threads are cast holes that require threads to be cut (tapped) into the metal.

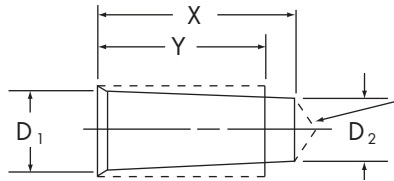

Tip or Spherical Radius Optional

The table below provides the dimensional tolerances for diameter, depth and draft for each specified thread type (Unified and Metric Series). When required, cored holes in Al, Mg, Zn and ZA may be tapped without removing draft. This Standard Tolerance recommendation is based on allowing 85% of full thread depth at the bottom D_2 (small end) of the cored hole and 55% at the top D_1 (large end)

of the cored hole. A countersink or radius is also recommended at the top of the cored hole. This provides relief for any displaced material and can also serve to strengthen the core.

Threads extend through the cored hole as by Y. X shows the actual hole depth. As with the countersink at the top of the hole, the extra hole length provides relief for displaced material and allows for full thread engagement. Tolerances below apply to all alloys.

Table S-4A-9: Cored Holes for Cut Threads (Standard Tolerances) – Unified Series and Metric Series

Unified Series/Class	Hole Diameter		Thread Depth Y, Max.	Hole Depth X, Max.
	D_1 , Max.	D_2 , Min.		
	inches	inches	inches	inches
6-32, UNC/2B, 3B	0.120	0.108	0.414	0.508
6-40, UNF/2B	0.124	0.114	0.345	0.420
8-32, UNC/2B	0.146	0.134	0.492	0.586
8-36, UNF/2B	0.148	0.137	0.410	0.493
10-24, UNC/2B	0.166	0.151	0.570	0.695
10-32, UNF/2B	0.172	0.160	0.475	0.569
12-24, UNC/2B	0.192	0.177	0.648	0.773
12-28, UNF/2B	0.196	0.182	0.540	0.647
1/4A-20, UNC/1B, 2B	0.221	0.203	0.750	0.900
1/4A-28, UNF/1B, 2B	0.230	0.216	0.500	0.607
5/16-18, UNC/1B, 2B	0.280	0.260	0.781	0.948
5/16-24, UNF/1B, 2B	0.289	0.273	0.625	0.750
3/8-16, UNC/1B, 2B	0.339	0.316	0.938	1.125
3/8-24, UNF/1B, 2B	0.351	0.336	0.656	0.781
7/16-14, UNC/1B, 2B	0.396	0.371	1.094	1.308
7/16-20, UNF/1B, 2B	0.409	0.390	0.766	0.916
1/2-13, UNC/1B, 2B	0.455	0.428	1.250	1.481
1/2-20, UNF/1B, 2B	0.471	0.453	0.750	0.900
9/16-12, UNC/1B, 2B	0.514	0.485	1.406	1.656
9/16-18, UNF/1B, 2B	0.530	0.510	0.844	1.010
5/8-11, UNC/1B, 2B	0.572	0.540	1.563	1.835
5/8-18, UNF/1B, 2B	0.593	0.573	0.781	0.948
3/4A-10, UNC/1B, 2B	0.691	0.657	1.688	1.988
3/4A-16, UNF/1B, 2B	0.714	0.691	0.938	1.125
7/8-9, UNC/1B, 2B	0.810	0.772	1.750	2.083
7/8-14, UNF/1B, 2B	0.833	0.808	1.094	1.308
1-8, UNC/1B, 2B	0.927	0.884	2.000	2.375
1-12, UNF/1B, 2B	0.951	0.922	1.250	1.500

Metric Series Thread Size (A)	Hole Diameter		Thread Depth Y, Max.	Hole Depth X, Max.
	D_1 , Max.	D_2 , Min.		
	mm	mm	mm	mm
M3.5 X 0.6	3.168	2.923	7.88	9.68
M4 X 0.7	3.608	3.331	9.00	11.10
M5 X 0.8	4.549	4.239	11.25	13.65
M6 X 1	5.430	5.055	13.50	16.50
M8 X 1.25	7.281	6.825	18.00	21.75
fM8 X 1	7.430	7.055	14.00	17.00
M10 X 1.5	9.132	8.595	22.50	27.00
fM10 X 0.75	9.578	9.285	10.00	12.25
fM10 X 1.25	9.281	8.825	20.00	23.75
M12 X 1.75	10.983	10.365	27.00	32.25
fM12 X 1	11.430	11.055	15.00	18.00
fM12 X 1.25	11.281	10.825	18.00	21.75
M14 X 2	12.834	12.135	31.50	37.50
fM14 X 1.5	13.132	12.595	24.50	29.00
fM15 X 1	14.430	14.055	15.00	18.00
M16 X 2	14.834	14.135	32.00	38.00
fM16 X 1.5	15.132	14.595	24.00	28.50
fM17 X 1	16.430	16.055	15.30	18.30
fM18 X 1.5	17.132	16.595	24.30	28.80
M20 X 2.5	18.537	17.675	40.00	47.50
fM20 X 1	19.430	19.055	15.00	18.00
fM20 X 1.5	19.132	18.595	25.00	29.50
fM22 X 1.5	21.132	20.595	25.30	29.80
M24 X 3	22.239	21.215	48.00	57.00
fM24 X 2	22.834	22.135	30.00	36.00
fM25 X 1.5	24.132	23.595	25.00	29.50
fM27 X 2	25.834	25.135	33.75	39.75
M30 X 3.5	27.941	26.754	60.00	70.50

f = Fine Pitch Series

Cored Holes for Cut Threads: Precision Tolerances

Cored holes for cut threads are cast holes that require threads to be cut (tapped) into the metal. The table below provides the dimensional tolerances for diameter, depth and draft for each specified thread type (Unified and Metric Series). When required, cored holes in Al, Mg, Zn and ZA may be tapped without removing draft. This Precision Tolerance recommendation is based on allowing 95% of full thread depth at the bottom D_2 (small end) of the cored hole and the maximum minor diameter at the top D_1 (large end) of the cored hole. A countersink or radius is also recommended at the top of the cored hole. This provides relief for any displaced material and can also serve to strengthen the core.

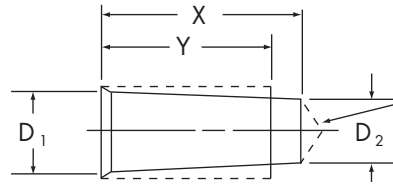

Tip or Spherical Radius Optional

The Precision Tolerance values shown represent greater casting accuracy involving extra precision in die construction and/or special control in production. They should be specified only when and where necessary, since additional cost may be involved.

Table P-4A-9: Cored Holes for Cut Threads (Precision Tolerances) – Unified Series and Metric Series

Unified Series/ Class (A)	Hole Diameter		Thread Depth Y, Max.	Hole Depth X, Max.
	D_1 , Max.	D_2 , Min.		
	inches	inches	inches	
0-80, UNF/2B, 3B	(0.051)	(0.047)	(0.130)	(0.163)
1-64, UNC/2B, 3B	(0.062)	(0.057)	(0.200)	(0.250)
1-72, UNF/2B, 3B	(0.064)	(0.059)	(0.160)	(0.200)
2-56, UNC/2B, 3B	(0.074)	(0.068)	(0.240)	(0.300)
2-64, UNF/2B, 3B	(0.075)	(0.070)	(0.200)	(0.250)
3-48, UNC/2B, 3B	(0.085)	(0.078)	(0.280)	(0.350)
3-56, UNF/2B, 3B	(0.087)	(0.081)	(0.220)	(0.275)
4A-40, UNC/2B, 3B	(0.094)	(0.086)	(0.320)	(0.400)
4A-48, UNF/2B, 3B	(0.097)	(0.091)	(0.240)	(0.300)
5-40, UNC/2B, 3B	0.106	0.099	0.280	0.350
5-44, UNF/2B, 3B	0.108	0.102	0.240	0.300
6-32, UNC/2B, 3B	0.114	0.106	0.350	0.438
6-40, UNF/2B	0.119	0.112	0.270	0.338
8-32, UNC/2B	0.139	0.132	0.290	0.363
8-36, UNF/2B	0.142	0.135	0.260	0.325
10-24, UNC/2B	0.156	0.147	0.390	0.488
10-32, UNF/2B	0.164	0.158	0.240	0.300
12-24, UNC/2B	0.181	0.173	0.340	0.425
12-28, UNF/2B	0.186	0.179	0.270	0.338
1/4A-20, UNC/1B, 2B	0.207	0.199	0.370	0.463
1/4A-28, UNF/1B, 2B	0.220	0.213	0.270	0.338
5/16-18, UNC/1B, 2B	0.265	0.255	0.440	0.550
5/16-24, UNF/1B, 2B	0.277	0.270	0.310	0.388
3/8-16, UNC/1B, 2B	0.321	0.311	0.470	0.588
3/8-24, UNF/1B, 2B	0.340	0.332	0.340	0.425
7/16-14, UNC/1B, 2B	0.376	0.364	0.570	0.713
7/16-20, UNF/1B, 2B	0.395	0.386	0.400	0.500
1/2-13, UNC/1B, 2B	0.434	0.421	0.640	0.800
1/2-20, UNF/1B, 2B	0.457	0.449	0.370	0.463
9/16-12, UNC/1B, 2B	0.490	0.477	1.280	1.600
9/16-18, UNF/1B, 2B	0.515	0.505	0.880	1.100
5/8-11, UNC/1B, 2B	0.546	0.532	1.430	1.788
5/8-18, UNF/1B, 2B	0.578	0.568	0.930	1.163
3/4A-10, UNC/1B, 2B	0.663	0.647	1.590	1.988
3/4A-16, UNF/1B, 2B	0.696	0.686	0.950	1.188
7/8-9, UNC/1B, 2B	0.778	0.761	1.750	2.188
7/8-14, UNF/1B, 2B	0.814	0.802	1.200	1.500
1-8, UNC/1B, 2B	0.890	0.871	1.900	2.375
1-12, UNF/1B, 2B	0.928	0.914	1.340	1.675

Metric Series Thread Size (A)(B)	Hole Diameter		Thread Depth Y, Max.	Hole Depth X, Max.
	D_1 , Max.	D_2 , Min.		
	mm	mm	mm	mm
M1.6 X 0.35	(1.32)	(1.24)	(2.40)	(3.45)
M2 X 0.4	(1.68)	(1.59)	(3.00)	(4.20)
M2.5 X 0.45	(2.14)	(2.04)	(3.75)	(5.10)
M3 X 0.5	(2.60)	(2.49)	(4.50)	(6.00)
M3.5 X 0.6	2.99	2.88	5.25	7.05
M4 X 0.7	3.42	3.28	6.00	8.10
M5 X 0.8	4.33	4.17	7.50	9.90
M6 X 1	5.15	4.96	9.00	12.00
M8 X 1.25	6.91	6.70	12.00	15.75
fM8 X 1	7.15	6.96	12.00	15.00
M10 X 1.5	8.68	8.44	15.00	19.50
fM10 X 0.75	9.38	9.23	12.50	14.75
M10 X 1.25	8.91	8.70	15.00	18.75
M12 X 1.75	10.44	10.17	18.00	23.25
fM12 X 1	11.15	10.96	15.00	18.00
fM12 X 1.25	10.91	10.70	15.00	18.75
M14 X 2	12.21	11.91	21.00	27.00
fM14 X 1.5	12.68	12.44	21.00	25.50
fM15 X 1	14.15	13.96	18.75	21.75
M16 X 2	14.21	13.91	28.00	34.00
fM16 X 1.5	14.68	14.44	24.00	28.50
fM17 X 1	16.15	15.96	17.00	20.00
fM18 X 1.5	16.68	16.44	22.50	27.00
M20 X 2.5	17.74	17.38	30.00	37.50
fM20 X 1	19.15	18.96	20.00	23.00
fM20 X 1.5	18.68	18.44	20.00	24.50
fM22 X 1.5	20.68	20.44	22.00	26.50
M24 X 3	21.25	20.85	36.00	45.00
fM24 X 2	22.21	21.91	30.00	36.00
fM25 X 1.5	23.68	23.44	25.00	29.50
fM27 X 2	25.21	24.91	27.00	33.00
M30 X 3.5	26.71	26.31	37.50	48.00

f = Fine Pitch Series

Values in italics and parentheses are achievable but should be discussed with the die caster prior to finalization of a casting design.

Cored holes for formed threads are specified in die castings as Precision Tolerances, because they require special control in production. The specific diameter, depth and draft required will determine the added cost.

Engineering & Design: Coordinate Dimensioning

Cored Holes for Formed Threads: Precision Tolerances

The Precision Tolerance recommendations for cored holes for formed threads, on the opposite page, are based on allowing 75% of full thread depth at the bottom D_2 (small end) of the cored hole and 50% at the top D_1 (large end) of the cored hole. When required, cored holes in aluminum, zinc and magnesium may be tapped without removing draft.

Cold form taps displace material in an extrusion or swaging process. As a result, threads are stronger because the material is work hardened as a part of the process for forming threads. Because material is displaced, a countersink is recommended at the ends of through holes and at the entry of blind holes.

Tests indicate that thread height can be reduced to 60% without loss of strength, based on the fact cold formed threads in die castings are stronger than conventional threads. However, the use of 65% value is strongly recommended.

Since cored holes in castings must have draft (taper), the 65% thread height Y should be at a depth that is an additional one-half of the required engagement length of the thread in the hole.

Blind holes should be cored deep enough to allow a four (4) thread lead at the bottom of the hole. This will result in less burr around the hole and longer tool life. Hole sizes of #6 or less, or metric M3 or less, are recommended for through holes only.

Cold form tapping is not recommended for holes with a wall thickness less than two-thirds the normal diameter of the thread.

The Precision Tolerance recommendation should be considered as a starting point with respect to depth recommendations. There are many applications that do not require the percent of thread listed here. If a lesser percent of thread can be permitted, this would, in turn, allow more draft and a deeper hole. Amount and direction of required strength can be determined by testing.

Note:

Tolerances for cored holes for thread forming fasteners (self tapping screws) should be provided by the manufacturer of the specific type of thread forming fastener to be used.

Cored Holes for Formed Threads: Precision Tolerances

The tolerances below apply to Al, Mg, Zn and ZA die casting alloys, as footnoted. Note that, when required, cored holes in aluminum, zinc, and magnesium may be tapped without removing draft.

Guidelines are provided on the opposite page regarding thread height, depth, and limitations on wall thickness.

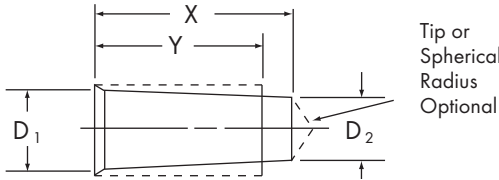

The Precision Tolerance values shown represent greater casting accuracy involving extra precision in construction and/or special control in production. They should be specified only when and where necessary, since additional cost may be involved.

Table P-4A-10: Cored Holes for Formed Threads (Precision Tolerances) – Unified Series and Metric Series

Unified Series Class ^(A)	Hole Diameter		Thread Depth Y, Max.	Hole Depth X, Max.	Metric Series Thread Size ^{(A)(B)}	Hole Diameter		Thread Depth Y, Max.	Hole Depth X, Max.
	D ₁ , Max.	D ₂ , Min.				D ₁ , Max.	D ₂ , Min.		
	inches	inches	inches	inches		mm	mm	mm	mm
0-80, UNF/2B, 3B	(0.0558)	(0.0536)	(0.090)	(0.120)	M1.6 X 0.35	(1.481)	(1.422)	(2.4)	(3.2)
1-64, UNC/2B, 3B	(0.0677)	(0.0650)	(0.110)	(0.146)	M2 X 0.4	(1.864)	(1.796)	(3.0)	(4.0)
1-72, UNF/2B, 3B	(0.0683)	(0.0659)	(0.110)	(0.146)	M2.5 X 0.45	(2.347)	(2.271)	(3.8)	(5.0)
2-56, UNC/2B, 3B	(0.0799)	(0.0769)	(0.129)	(0.172)	M3 X 0.5	(2.830)	(2.745)	(4.5)	(6.0)
2-64, UNF/2B, 3B	(0.0807)	(0.0780)	(0.129)	(0.172)	M3.5 X 0.6	3.296	3.194	7.0	10.5
3-48, UNC/2B, 3B	(0.0919)	(0.0884)	(0.149)	(0.198)	M4 X 0.7	3.762	3.643	8.0	12.0
3-56, UNF/2B, 3B	(0.0929)	(0.0899)	(0.149)	(0.198)	M5 X 0.8	4.728	4.592	10.0	15.0
4A-40, UNC/2B, 3B	(0.1035)	(0.0993)	(0.168)	(0.224)	M6 X 1	5.660	5.490	12.0	18.0
4A-48, UNF/2B, 3B	(0.1049)	(0.1014)	(0.168)	(0.224)	M8 X 1.25	7.575	7.363	16.0	24.0
5-40, UNC/2B, 3B	(0.1165)	(0.1123)	(0.188)	(0.250)	fM8 X 1	7.660	7.490	16.0	24.0
5-44, UNF/2B, 3B	(0.1173)	(0.1134)	(0.188)	(0.250)	M10 X 1.5	9.490	9.235	20.0	30.0
6-32, UNC/2B, 3B	(0.1274)	(0.1221)	(0.207)	(0.276)	fM10 X 0.75	9.745	9.618	12.5	30.0
6-40, UNF/2B	(0.1295)	(0.1253)	(0.207)	(0.276)	fM10 X 1.25	9.575	9.363	20.0	30.0
8-32, UNC/2B	0.153	0.148	0.328	0.492	M12 X 1.75	11.41	11.11	24.0	36.0
8-36, UNF/2B	0.155	0.150	0.328	0.492	fM12 X 1	11.66	11.49	18.0	36.0
10-24, UNC/2B	0.176	0.169	0.380	0.570	fM12 X 1.25	11.58	11.36	18.0	36.0
10-32, UNF/2B	0.179	0.174	0.380	0.570	M14 X 2	13.32	12.98	28.0	42.0
12-24, UNC/2B	0.202	0.195	0.432	0.648	fM14 X 1.5	13.49	13.24	21.0	42.0
12-28, UNF/2B	0.204	0.198	0.432	0.648	fM15 X 1	14.66	14.49	18.8	45.0
1/4A-20, UNC/1B, 2B	0.233	0.225	0.500	0.750	M16 X 2	15.32	14.98	32.0	48.0
1/4A-28, UNF/1B, 2B	0.238	0.232	0.500	0.750	fM16 x 1.5	15.49	15.24	24.0	48.0
5/16-18, UNC/1B, 2B	0.294	0.284	0.703	0.938	fM17 X 1	16.66	16.49	17.0	51.0
5/16-24, UNF/1B, 2B	0.298	0.291	0.703	0.938	fM18 X 1.5	17.49	17.24	27.0	54.0
3/8-16, UNC/1B, 2B	0.354	0.343	0.844	1.125	M20 X 2.5	19.15	18.73	40.0	60.0
3/8-24, UNF/1B, 2B	0.361	0.354	0.844	1.125	fM20 X 1	19.66	19.49	20.0	60.0
7/16-14, UNC/1B, 2B	0.413	0.401	0.984	1.313	fM20 X 1.5	19.49	19.24	30.0	60.0
7/16-20, UNF/1B, 2B	0.421	0.412	0.984	1.313	fM22 X 1.5	21.49	21.24	27.5	66.0
1/2-13, UNC/1B, 2B	0.474	0.461	1.125	1.500	M24 X 3	22.98	22.47	48.0	72.0
1/2-20, UNF/1B, 2B	0.483	0.475	1.125	1.500	fM24 X 2	23.32	22.98	36.0	72.0
9/16-12, UNC/1B, 2B	0.534	0.520	1.266	1.688	fM25 X 1.5	24.49	24.24	31.3	75.0
9/16-18, UNF/1B, 2B	0.544	0.534	1.266	1.688	fM27 X 2	26.32	25.98	40.5	81.0
5/8-11, UNC/1B, 2B	0.594	0.579	1.406	1.875	M30 X 3.5	28.81	28.22	60.0	90.0
5/8-18, UNF/1B, 2B	0.606	0.597	1.406	1.875					
3/4A-10, UNC/1B, 2B	0.716	0.699	1.500	2.250					
3/4A-16, UNF/1B, 2B	0.729	0.718	1.500	2.250					
7/8-9, UNC/1B, 2B	0.837	0.818	1.750	2.625					
7/8-14, UNF/1B, 2B	0.851	0.839	1.750	2.625					
1-8, UNC/1B, 2B	0.958	0.936	2.000	3.000					
1-12, UNF/1B, 2B	0.972	0.958	2.000	3.000					

Values in italics and parentheses are achievable but should be discussed with the die caster prior to finalization of a casting design.

The values shown for tapered pipe threads represent Standard Tolerances, or normal die casting production practice at the most economical level. N.P.T. threads should be specified, where possible, for most efficient production.

Cored Holes for Pipe Threads: Standard Tolerances

Most pipes require taper to ensure that the connections seal as more of the thread is engaged. For example, when a garden hose is first threaded onto a threaded connection, it is very loose. As more of the thread is engaged by screwing the hose on, there is less play as the fitting gets tighter. A good fitting will become tight before the threads bottom out. Additional hole beyond the threads is provided so that fitting can be tightened against the taper to achieve the desired seal. Taper also allows for part wear.

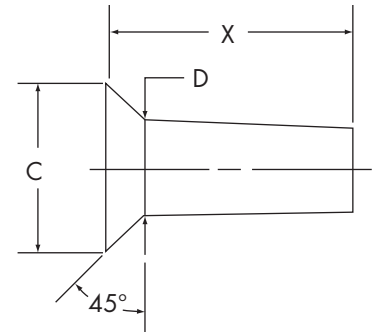

There are two pipe thread taper standards. National Pipe Taper (N.P.T.) is the most common standard. A fitting should seal with at least one revolution of turn still available on the thread. The fitting should not bottom out in the hole. Standard taper is normally 3/4 inches per foot. However, taper for special applications is determined by required strength formerly discussed in Cored Holes for Formed Threads.

Aeronautical National Pipe Taper (A.N.P.T.) is basically the same as N.P.T. pipe threads. However, diameter, taper and thread form are carefully controlled for military and aviation use. There is an associated cost increase using the A.N.P.T. standard since tighter controls are required.

The cored holes specified below are suitable for both N.P.T. and A.N.P.T. threads. The 1° 47' taper per side is more important for A.N.P.T. than N.P.T. threads. There is no comparable metric standard for pipe threads.

For the most economical die casting production, N.P.T. threads should be specified where possible. A.N.P.T. threads may require additional steps and cost.

The required taper for all N.P.T. and A.N.P.T. sizes is 1° 47'±10' per side.

The differences in measurement of these threads represent the differences in function. The N.P.T. thread quality is determined by use of the L1 thread plug gauge. This thread is intended as a tapered sealing thread using pipe dope or another sealing agent to provide a leak tight seal.

The A.N.P.T. thread, as well as the N.P.T.F. (American National Taper Dryseal Pressure-Tight Joints) thread, represents a tapered thread that is capable of sealing without the aid of sealing agents; thus their identification as dry seal threads. These threads are checked with the use of an L1 and L3 thread member as well as a six step plug gauge to verify thread performance on the crests. The difference of the A.N.P.T. and N.P.T.F. is in the tolerance of the gauging. The dry seal threads are more difficult to cast as the draft angle of the cores must be 1° 47' per side and without drags to avoid lobing at the tapping operation or an L3 failure.

Table S-4A-11: Cored Holes for Tapered Pipe Threads Both N.P.T. and A.N.P.T.

Tap size	"D" Diameter	Minimum Depth "X" for Standard Tap	Minimum Depth "X" for Short Projection Tap	"C" Diameter ±.020
1/16 - 27	0.245 ±0.003	0.609	0.455	0.327
1/8 - 27	0.338 ±0.003	0.609	0.458	0.421
1/4 - 18	0.440 ±0.003	0.859	0.696	0.577
3/8 - 18	0.575 ±0.004	0.875	0.702	0.702
1/2 - 14	0.713 ±0.004	1.109	0.918	0.890
3/4 - 14	0.923 ±0.004	1.109	0.925	1.077
1 - 11 1/2	1.160 ±0.005	1.343	1.101	1.327
1 1/4 - 11 1/2	1.504 ±0.006	1.375	1.113	1.656
1 1/2 - 11 1/2	1.743 ±0.007	1.390	1.127	1.921
2 - 11 1/2	2.217 ±0.008	1.375	1.205	2.515
2 1/2 - 8	2.650 ±0.008	1.953	1.697	2.921
3 - 8	3.277 ±0.009	2.031	1.780	3.546

Cast Threads

Threads can be cast in aluminum, magnesium, or zinc. Normally, cast threads are confined to external threads where precision class fits are not required. If a precision class fit is required, the die caster should be consulted. Secondary machining may be required.

External threads can be formed either across the parting line of a die (fig.1) or with slides (fig. 2). Tolerances shown in Table S-4A-12 reflect the method by which the threads are formed.

The Major diameter shall be in compliance with the specified thread form definition as agreed upon between the purchaser and the die caster.

Threaded parts are identified by a series of numbers known as a thread callout. A typical thread callout may be 1/16-28-0.960-0.580-0.12-7.02 where:

1/16 is the nominal thread size

28 is the number of Threads Per Inch (TPI)

Table S-4A-12: Die Cast Threads Tolerances

Method of Forming Threads	Figure 1		Figure 2	
	Zinc	Aluminum/Magnesium	Zinc	Aluminum/Magnesium
Minimum pitch or maximum number of threads per inch	32	24	32	24
Minimum O.D.	0.187" (4.763 mm)	0.250" (6.350 mm)	0.187" (4.763 mm)	0.250" (6.350 mm)
Tolerance on thread lead per inch of length	±.005" (±.127 mm)	±.006" (±.152 mm)	±.005" (±.127 mm)	±.006" (±.152 mm)
Minimum Pitch Diameter Tolerance	±.004" (±.102 mm)	±.005" (±.127 mm)	±.005" (±.127 mm)	±.006" (±.152 mm)

Notes:

1. An additional trim or chasing operation may be necessary to remove flash formed between threads.
2. Direct tolerances shown should be applied wherever possible rather than specifying thread class or fit.
3. The values indicated include parting line, moving die component and linear dimension tolerances. If tighter tolerances are required, the caster should be consulted.

Figure 3. Design Considerations

The recommended designs for terminating a die cast external thread are shown below:

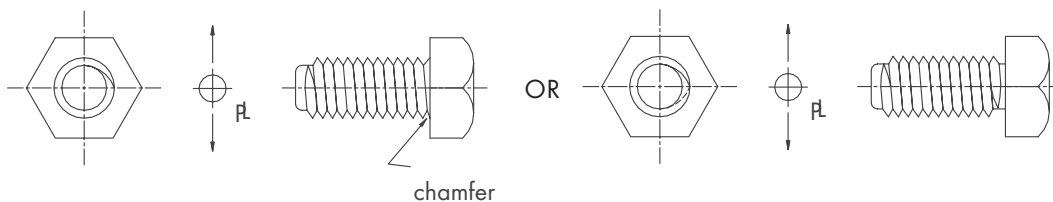

Flats on the thread at the parting line will greatly simplify the trimming operation and result in the most economical means of producing die cast threads.

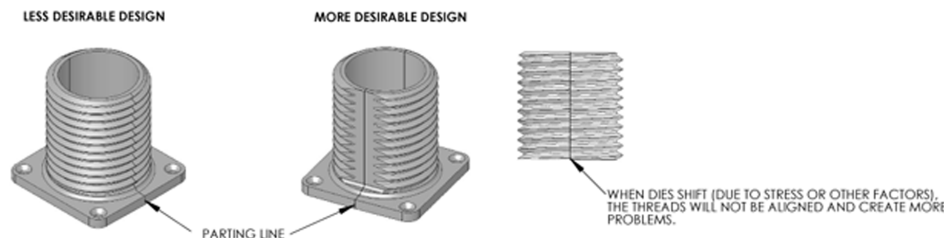

Machining stock allowances are a function of linear dimensions tolerances and parting line tolerances, and whether Standard or Precision Tolerances are required. Precision Tolerance values will usually represent greater casting accuracy involving extra precision in die construction and/or special control in production. For economical production, they should be specified only when and where necessary.

Engineering & Design: Coordinate Dimensioning

Machining Stock Allowance (Standard and Precision)

It is important to understand that the optimum mechanical properties and density of a casting are at or near the surface. If machining is to be performed on a casting, a minimum amount of material should be removed so as not to penetrate the less dense portion. However, to assure cleanup, an allowance must be provided for both the machining variables and the casting variables covered by NADCA Standards in this section.

Datum structure is very important to help minimize or eliminate the effect of these variables. (See Datum Reference Framework in Geometric Dimensioning, Section 5, for a preferred datum framework.) Best results are attained if the casting is located from datum points that are in the same die half as the feature to be machined.

Consulting with your caster early will help minimize the effect of tolerance accumulation and unnecessary machining.

Normal minimum machining allowance is 0.010 in. (0.25 mm) to avoid excessive tool wear and minimize exposure of porosity. The maximum allowance is the sum of this minimum, the machining allowance and the casting allowance.

Machining Stock Allowance Comparative Example: Precision Tolerances

	Example A Datum Points In Same Die Half	Example B Datum Points In Opposite Die Half
Minimum Machine Stock Allowance inches (mm)	0.010 (0.25 mm)	0.010 (0.25 mm)
Machining Allowances (± 0.001 in. or ± 0.026 mm)	0.002 (0.05 mm)	0.002 (0.05 mm)
Linear Casting Allowance on 5.000 in. (127 mm)	0.012 (0.356 mm)	0.012 (0.356 mm)
Dimension Precision Tolerance ^(A)		
Across Parting Line Precision Tolerances ^(B)	—	0.008 (0.020 mm)
Maximum Stock	0.026 (0.56 mm)	0.034 (0.86 mm)
Casting Dimension ^(C)	5.017 ± 0.006 (127.45 ± 0.18 mm)	5.026 +0.014/-0.006 (127.66 +0.38/-0.18 mm)

^(A) ±0.007 (±0.18 mm) P-4A-1-03 Precision Tolerance

^(B) ±0.008 (±0.20 mm) P-4A-2 Precision Tolerance

^(C) Casting dimension would not be needed if drawing was a combined drawing, only finish dimension of 5.00 ± 0.001 in. (127 ± 0.025 mm) would be needed.

Note:

No consideration was given to flatness in the above examples. The part shape may dictate a flatness tolerance that exceeds the sum of the linear and across parting line tolerances. (See Flatness Tolerances S-4A-8 and P-4A-8.) Additional machining would then be required unless the part can be straightened prior to machining.

Engineering & Design: Coordinate Dimensioning

Machining Stock Allowance (Standard and Precision)

Example:

Assume a 5.00 ± 0.001 in. (127 ± 0.025 mm) finish dimension on an aluminum die cast part that is 8.00 x 8.00 in. (203.2×203.2 mm).

In example "A" in the table on the facing page, surface to be machined is formed in the same die half as the datum points. In example "B", surface to be machined is formed in the opposite half of the die as the datum points. Both examples are shown using the Precision Tolerances for linear dimensions and parting line. The Standard Tolerances for linear dimensions and parting line would utilize the same format.

Machine Stock Tolerances

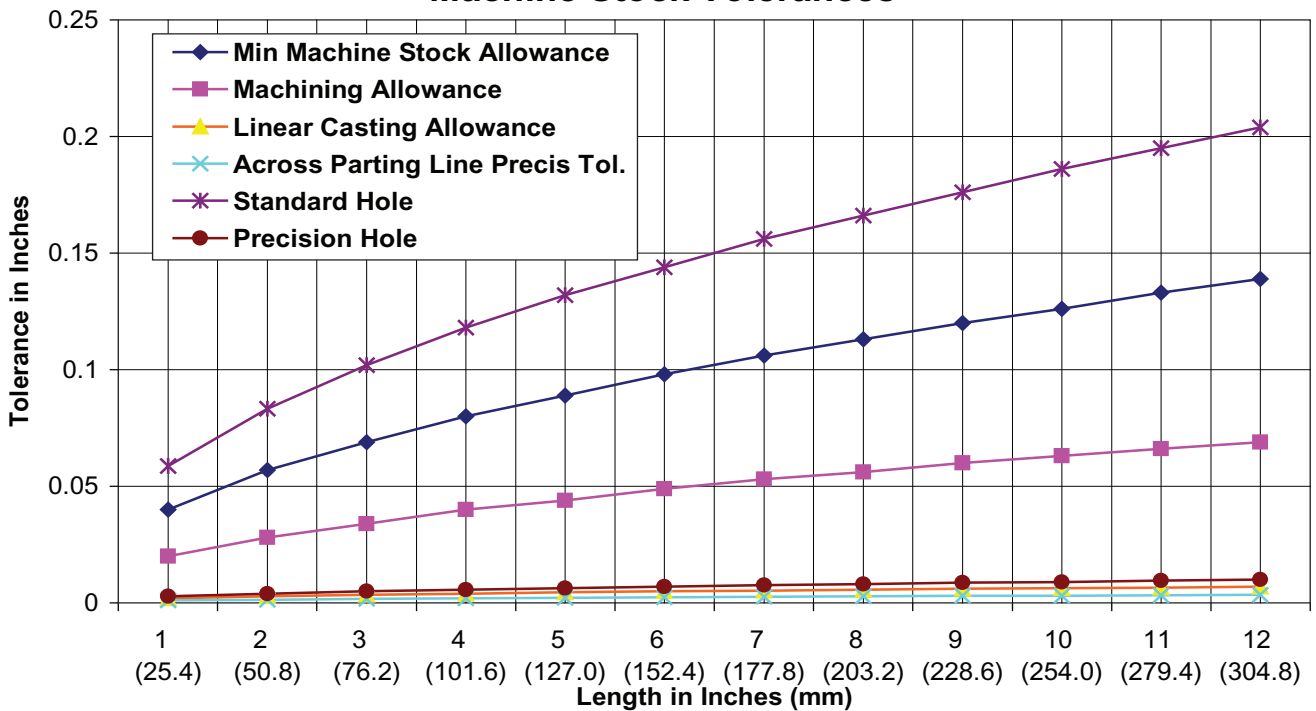

4A

Engineering & Design: Coordinate Dimensioning

Additional Considerations for Large Castings

1 Fillet Radii:

1.1: Definition: Wall thickness is the distance between two parallel or nearly parallel surfaces. Wall thickness may vary depending on the application of draft. Wall thickness should be maintained as uniform as possible. A general guideline would be to keep the range of thickness within 2X of the thinnest wall. A second guideline is to keep the wall as thin as possible to meet the castings functional requirements.

1.2: General: 0.14" (3.5mm (+/- 0.5mm))

1.2.1 Deviations: from the nominal condition are based upon product function and manufacturing process requirements.

2 Radii:

2.1 Fillet Radii:

2.1.1 General: 0.14" (+0.08/-0.04") [3.5mm (+2.0mm/-1.0mm)]

2.1.1.1 Deviations: from the nominal condition are based upon product function and manufacturing process requirements.

2.1.2 Minimum: 0.060" (1.5mm)

2.2 Corner Radii:

2.2.1 General: 0.060" (+0.08/-0.04") [1.5mm (+2mm/-1mm)]

2.2.1.1 Deviations: from the nominal condition are based upon product function and manufacturing process requirements.

2.2.2 Minimum: 0.020" (0.5mm)

3 Cores:

3.1 Guidelines: Cores should be used to minimize machining stock, and should be pulled perpendicular to each other. Use stepped cores where possible to minimize finish stock, reduce heavy sections, and minimize porosity.

3.2 Minimum: Cored hole diameter to be 0.25" (6.0mm) in and parallel to the direction of die draw.

3.3 For holes Less Than: 0.50" (12.5mm) diameter the core hole length to diameter (L/D) ratio should not exceed 4:1.

3.4 For Holes Greater Than: 0.50" (12.5mm) diameter the core pin length to diameter (L/D) ratio should not exceed 10:1.

4 Bosses:

4.1: Min. the boss height as much as possible.

4.2: When the height to diameter ratio of the boss exceeds 1, it is recommended that ribs be used to improve filling.

4.3: Design adjacent bosses with a minimum 0.25" (6.5mm) gap between bosses to minimize porosity.

Additional Considerations for Large Castings

5: Machining Stock:

5.1 General:

5.1.1: Machining stock should be minimized. Because die casting exhibit a “skin”, the densest fine-grained casting structure is near the surface.

5.1.2: Deviations from nominal condition are based upon product function and manufacturing process requirements.

5.2: 0.06” (1.5mm) maximum, on all faces, features found in the locator core, on remainder of part.

6 Ejector Pin Bosses:

6.1 Boss Diameter:

6.1.1: In functional areas size and location is dependent upon product function and manufacturing requirements.

6.1.2: In non-functional areas and on machined surfaces the ejector pin diameter is to be 0.38” (10.0mm) minimum and the location is by mutual agreement of OEM and die caster.

6.2 Surface Geometry:

6.2.1: 0.06” (1.5mm) raised to 0.03” (0.8mm) depressed.

7 Trimming & Cleaning:

7.1 Parting Lines:

7.1.1 Trim Ribs-Gate and Parting Line: 0.12” maximum (1.5mm)

7.1.2 Gates & Overflows: 0-0.059” (0-1.5mm)

7.1.3 Flash: As specified in normal standard.

7.2 Cored Holes: 0-0.02” (0-0.5mm)

7.3 Openings:

7.3.1: 0-0.06” (0-1.5mm) at the finish machined face

7.3.2: 0-0.03” (0-0.8mm) on as-cast surfaces

7.3.3: 0-0.01” (0-2.5mm) of corner radii

7.4 Corners - Sharp: Not removed.

7.5 Ejector Pin Flash (Max. Projection):

7.5.1: 0-0.12” (0-3.0mm) on machined surfaces.

7.5.2: 0-0.04” (0-1.0mm) on as-cast surfaces.

7.6 Machined Surfaces: 0.12” (0-0.3mm) max.

7.7 Seam Lines: 0-0.02” (0-0.5mm)

7.8 Negative trim (shearing): condition is allowed when the nominal wall thickness is maintained.

Engineering & Design: Coordinate Dimensioning